

Getting Started Guide

Cobalt Cube[®]



Contents

1	Introduction	3
2	Cobalt Cube overview	3
2.1	Cobalt Cube ports	3
2.2	Cobalt Cube basic hardware setup	4
2.3	Cobalt Cube power connector	4
3	First-time setup	5
3.1	Automated acceptance of Android Auto prompts	5
3.2	Product activation	5
3.2.1	Activating a Cobalt Cube	6
4	System customisation	7
4.1	Accessing Cobalt Cube settings	7
4.2	Settings PIN lock	8
4.3	Application specific settings	9
4.4	Changing the display name for an application	9
4.5	Navigation bar	10
4.5.1	Position	11
4.5.2	Navigation bar quick launch apps	12
4.6	Setting up the home screen	13
4.7	Setting a startup application	13
4.8	Setting a custom Network Time Protocol (NTP) server	14
4.9	Phone call support	15
4.9.1	Setup	15
4.10	Bluetooth Audio	16
4.10.1	Setup	17
4.10.2	Bluetooth Media Player	17
4.10.3	Bluetooth Automatic Reconnect	19
5	Updating the system image	19
5.1	Rebooting the Cobalt Cube	20
5.2	Activating new features	21
6	Use case: MCS Control	22
6.1	Introduction	22
6.2	Additional hardware requirements	23
6.3	Connectivity instructions	23
6.4	Working with the MCS Control app	24
6.5	Configuring the MCS Control application	26
7	Use case: MDT (Mobile Data Terminal) Control	27
7.1	Introduction	27
7.2	Additional hardware requirements	27
7.3	Connectivity instructions (Router)	28
7.4	Connectivity instructions (Direct)	28
7.5	Assign static IP address for Ethernet adapter Cobalt Cube	28
7.6	Assign static IP address for Ethernet adapter Windows PC	28
7.7	Working with the MDT application	29
7.8	MDT configuration	30
8	Use case: Smartphone Control	33
8.1	Introduction	33
8.2	Additional hardware requirements	33
8.3	Connectivity and set-up instructions	33
8.3.1	Wi-Fi with Wi-Fi Hotspot (recommended)	33
8.3.2	Wi-Fi with Router	35
8.3.3	USB (Android only)	35
8.3.4	Working with the Smartphone Control app	36
8.4	(OPTIONAL) Authentication	39

8.5	Auto-connection	39
8.6	Smartphone Control settings	40
8.6.1	Skip Bluetooth setup	40
8.6.2	Phone Navigation Bar (back, home)	40
8.6.3	Manage known devices	41
9	Use case: Genisys Control	41
9.1	Introduction	41
9.2	Additional hardware requirements	42
9.3	Connection instructions	42
9.4	Operating instructions	43
10	System utilities	45
10.1	Extracting system logs	45
10.1.1	UI overview	45
10.1.2	Additional information	46
10.1.3	Enabling logging	46
10.1.4	Enable user-facing log button	47
10.1.5	Extracting log files from the Cobalt Cube	48
11	Troubleshooting	50
11.1	Troubleshooting the Android Auto connection	50
11.2	Manual acceptance of Android Auto prompts	50
12	Frequently asked questions	51
12.1	Is it possible to navigate around the Cobalt Cube without establishing a connection to a vehicle head unit?	51
12.2	Is it possible to factory-reset the Cobalt Cube?	51
12.3	How long can the USB cable be for a reliable Android Auto connection?	52
12.4	The “Firmware Updating” pop-up shows on every boot after an update	52
12.5	Can two devices be connected to the Cobalt Cube for media audio simultaneously?	52
12.6	The phone’s display is very compressed in Smartphone Control.	52
12.7	The Smartphone Control hotspot remains pending indefinitely after being turned on.	52
12.8	The display of the Cobalt Cube turned off during an update and now it won’t power back on. What can I do?	52

1 Introduction

The instructions detailed in this document will allow you to set up and evaluate the Cobalt Cube® hardware, as long as it has been flashed with a VNC Automotive production system image.

This document covers the following use cases:

- MCS Control: provision of control of lights, sirens, etc. via the MCS Control app, which communicates with Standby® MCS hardware. The app emulates a particular MCS handset to provide this control and display of buttons.
- MDT Control: display of and interaction with a Microsoft® Windows® PC. This may be running, for example, Automatic Number Plate Recognition (ANPR) software connected to the Cobalt Cube's network. This use case also extends to mirroring other applications that may be present on the PC.
- Smartphone Control: display of and interaction with applications running on a connected device (either Android or iOS).
- Genisys Control: provision of control of lights, sirens, etc. via the Genisys Control app, which communicates with Ring Carnation® hardware. The app emulates a particular Ring Carnation® handset to provide this control and display of buttons and text notifications.

2 Cobalt Cube overview

2.1 Cobalt Cube ports

The Cobalt Cube has a series of labelled ports. This guide will refer to some of them, this section details their purpose.



Figure 1: Cobalt Cube

- HDMI: HDMI out port, to connect the Cobalt Cube directly to a screen over HDMI. This can be used for troubleshooting the Android Auto connection (section 11.1).
- POWER: 12V power input.
- GPS: port to connect a GPS antenna to improve GPS positioning. It is not required for any use case covered in this document.
- ETHERNET: port to connect an RJ45 cable, to allow an Ethernet connection to the network.
- OTG: USB-C port. Provides 5V power input to the device. USB OTG connectivity to 3rd party devices is supported.

- HOST: USB host Standard-A port. Can be used to connect USB thumb drives or USB peripherals (e.g., a mouse) to the Cobalt Cube.
- DCP: USB Standard-A port for DC output (5V).

2.2 Cobalt Cube basic hardware setup

1. For use cases which require network connectivity: connect one end of the Ethernet cable to the ETHERNET port on the Cobalt Cube, and the other end to a free port on the network router/switch.
2. Connect a USB-A to USB-C cable to the Cobalt Cube. The USB-A end should plug into the Android Auto port on the vehicle and the USB-C end should be connected to the Cobalt Cube.
3. Plug the 12V power block into the POWER port of the Cobalt Cube.

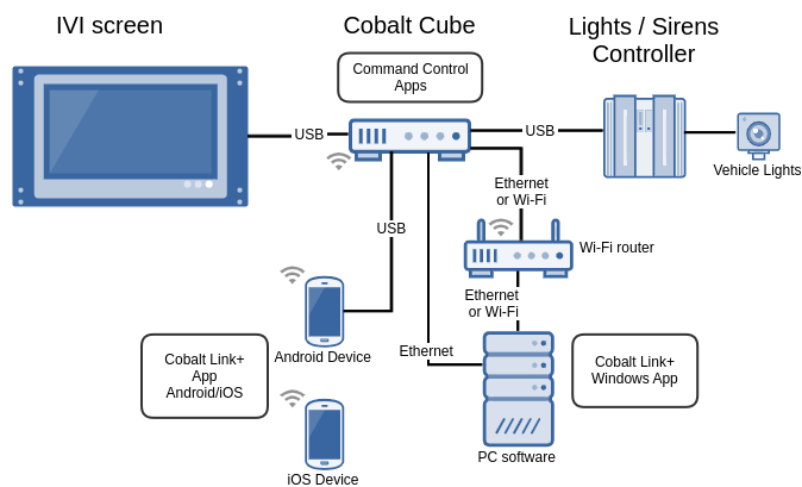

Figure 2: Possible hardware layout

2.3 Cobalt Cube power connector

Item	Part Number	Supplier Link
Power Connector	172167-1	https://uk.farnell.com/amp-te-connectivity/172167-1/plug-housing-4way/dp/1248283
Metal Contacts (x3)	170362-1	https://uk.farnell.com/amp-te-connectivity/170362-1/contact-socket-22-18-awg-crimp/dp/1772741

The image below shows the side view of the power connector included with the Cobalt Cube.

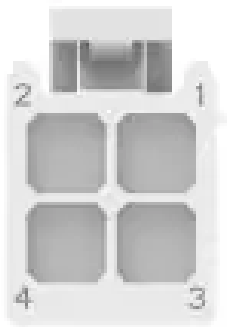

Figure 3: Cobalt Cube power connector

The connector can be cabled into the vehicle as follows:

Pin number	Function
1	Ground
2	-
3	Battery plus
4	Accessory

For the Cobalt Cube to operate correctly, it must receive a constant 12v supply to both the battery plus and accessory pins. Therefore, it is advised to connect both cables to the same battery.

If the vehicle has an auxiliary battery to keep devices powered when the engine/main battery is off, the Cobalt Cube should have both battery plus and accessory connected to this auxiliary supply.

3 First-time setup

3.1 Automated acceptance of Android Auto prompts

The first time the Cobalt Cube is connected to a particular vehicle there are setup prompts from Android Auto that need to be accepted. This process has been automated so that no user interaction is required. The Cobalt Cube needs to be powered on and plugged into the vehicle, then after 1-2 minutes, the Cobalt Cube screen should appear on the head unit. If the Cobalt Cube does not show on the head unit, follow the troubleshooting steps in section 11.1.

3.2 Product activation

The Cobalt Cube must be activated before it can be used. This is part of a wider, new addition to the product in version 2.0, namely Enterprise Device Management for your fleet of Cobalt Cube units. The feature supports dynamic configuration and deployment of apps, services and settings. This is particularly useful for batches of units installed and/or managed by the same supplier, which are in use by different groups of users with differing needs. As will be detailed, product activation involves a unique code(s), including all the dynamic configuration required for the deployed unit(s).

Product activation can be carried out before or after the unit has been fitted in a vehicle. When activating outside of a vehicle, attach an HDMI monitor and a mouse. In a vehicle, the vehicle's head unit can be used when activating the Cobalt Cube. Until a Cobalt Cube is activated, it will remain on the screen shown in Figure 4.

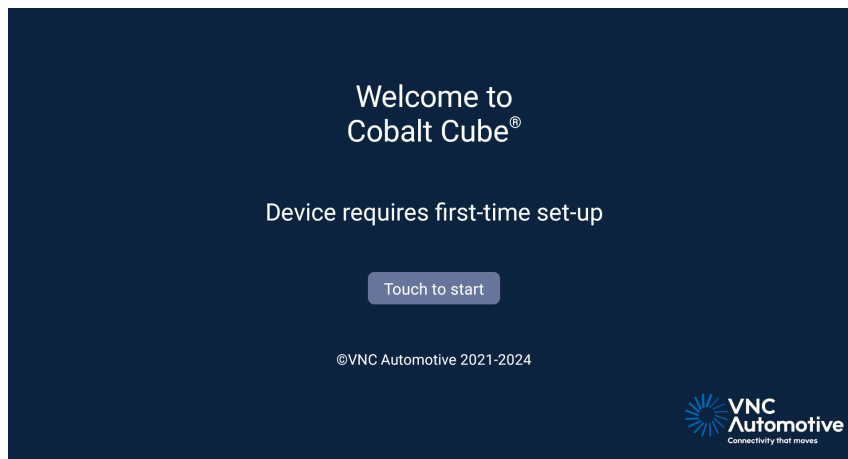

Figure 4: Welcome screen for Cobalt Cube activation

3.2.1 Activating a Cobalt Cube

On the screen in Figure 4, click “Touch to start”. The screen in Figure 5 will appear. Put your activation code on the USB storage device. It is important that this file is not renamed between receiving it from VNC Automotive and applying it to a Cobalt Cube. If you do not have an activation code, please contact VNC Automotive quoting the serial number on the label of your Cobalt Cube.

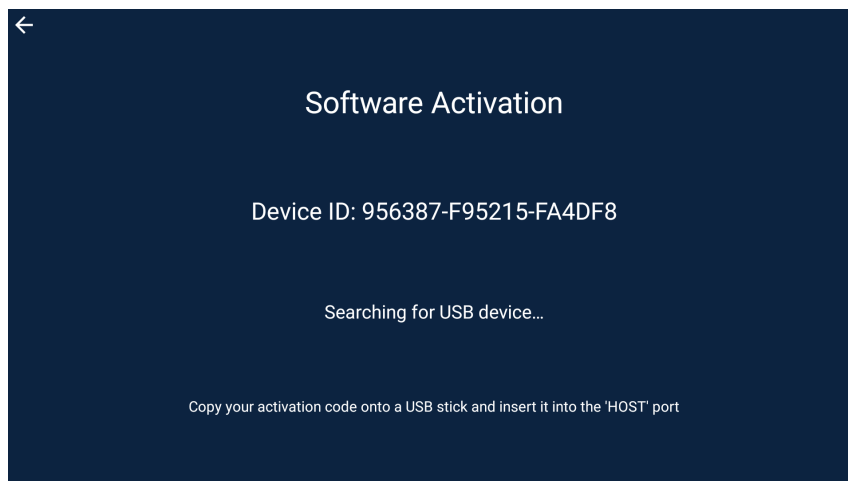

Figure 5: Activation screen

Insert the storage device with the activation code into the Cobalt Cube’s “HOST” port. When activating the Cobalt Cube in a vehicle, it may be easier to do this before starting the engine, if the Cobalt Cube is stored out of reach from the driver’s seat. When the storage device is detected by the Cobalt Cube, it will read the activation code and start the activation process, which should only take a few seconds. This will enable all purchased apps and apply any settings that have been specified in the activation code. Upon a successful activation, the screen in Figure 6 will appear. Touch anywhere to navigate to the launcher screen shown in Figure 7.

Note: if the storage device is not detected after ten seconds, try removing it and re-inserting it.

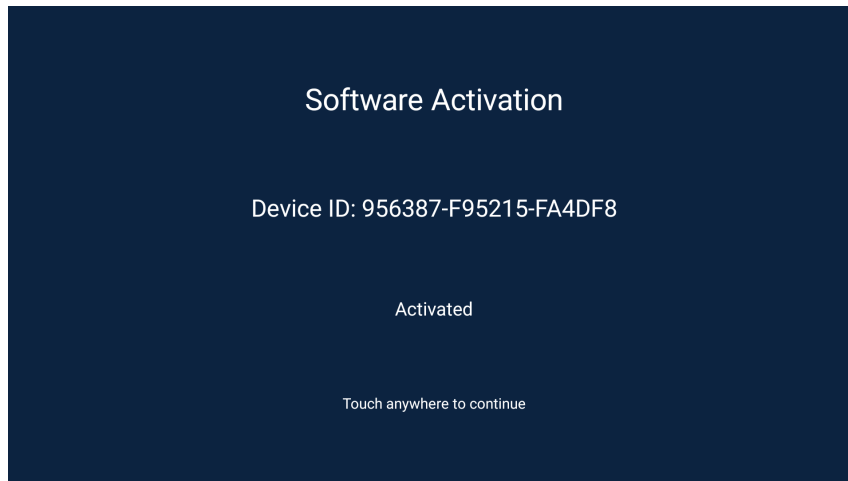

Figure 6: Activated screen

4 System customisation

The Cobalt Cube comes pre-installed with Android and includes a selection of applications based on the options purchased. The Android image can be updated (see section 5). All installed applications can be launched from the Cobalt Cube launcher, shown in Figure 7.

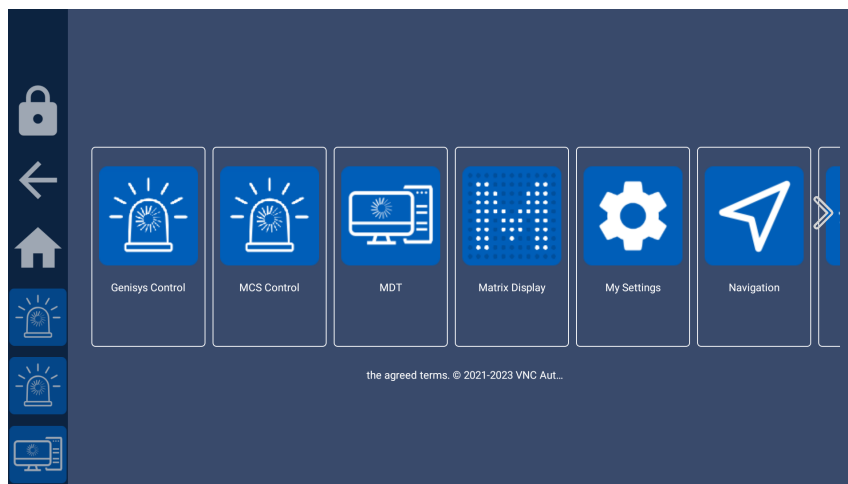

Figure 7: Cobalt Cube launcher

4.1 Accessing Cobalt Cube settings

The Cobalt Cube settings are accessed through a hidden menu on the main screen. This menu may be accessed by triple-tapping the bottom left corner of the main screen:



Figure 8: Area to triple-tap for Cobalt Cube settings

4.2 Settings PIN lock

The Cobalt Cube settings page is protected by a pin lock to prevent unwanted user tampering when the unit is deployed.



Figure 9: Settings PIN lock

The Cobalt Cube ships with a default pin code of: 2823

You can change this default pin once you access the settings menu.

Note: if you forget your updated pin there is no way to reset it.

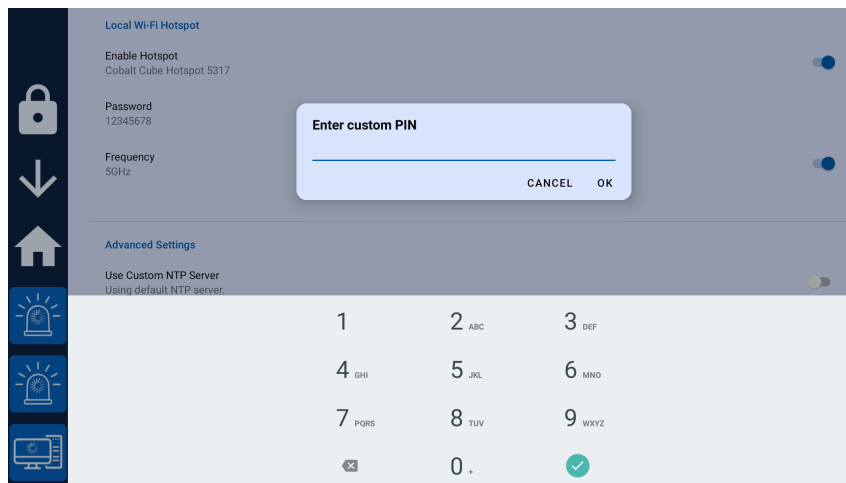

Figure 10: Custom PIN entry

4.3 Application specific settings

Some applications on the Cobalt Cube have their own settings menus. These can be found at the top of the Cobalt Cube settings page. A single tap on each listed icon will launch the settings for that app.

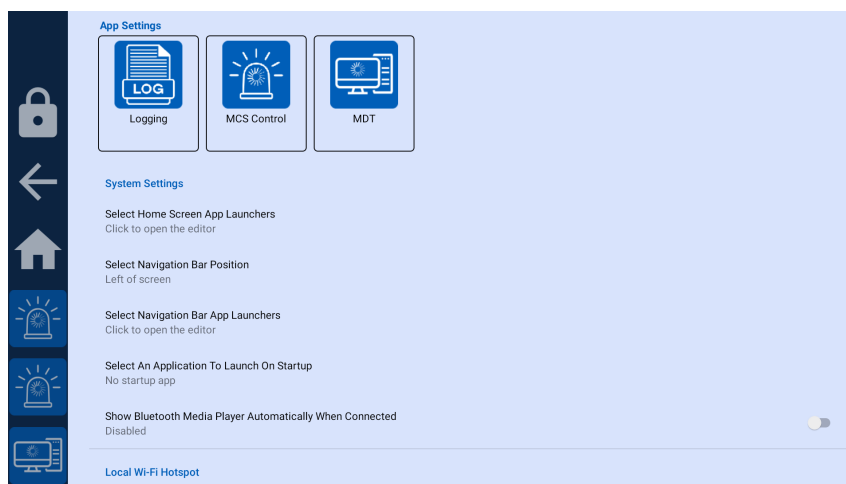

Figure 11: Application settings

4.4 Changing the display name for an application

Applications that support their own settings also support having their display name changed on the Cobalt Cube main screen. To enter a display name for an app, press and hold on the application icon at the bottom of the Cobalt Cube settings menu until the name change dialog appears.

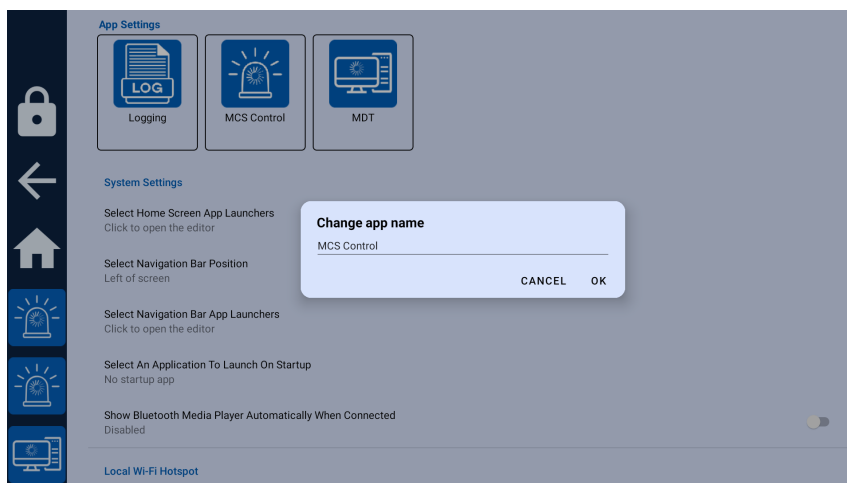
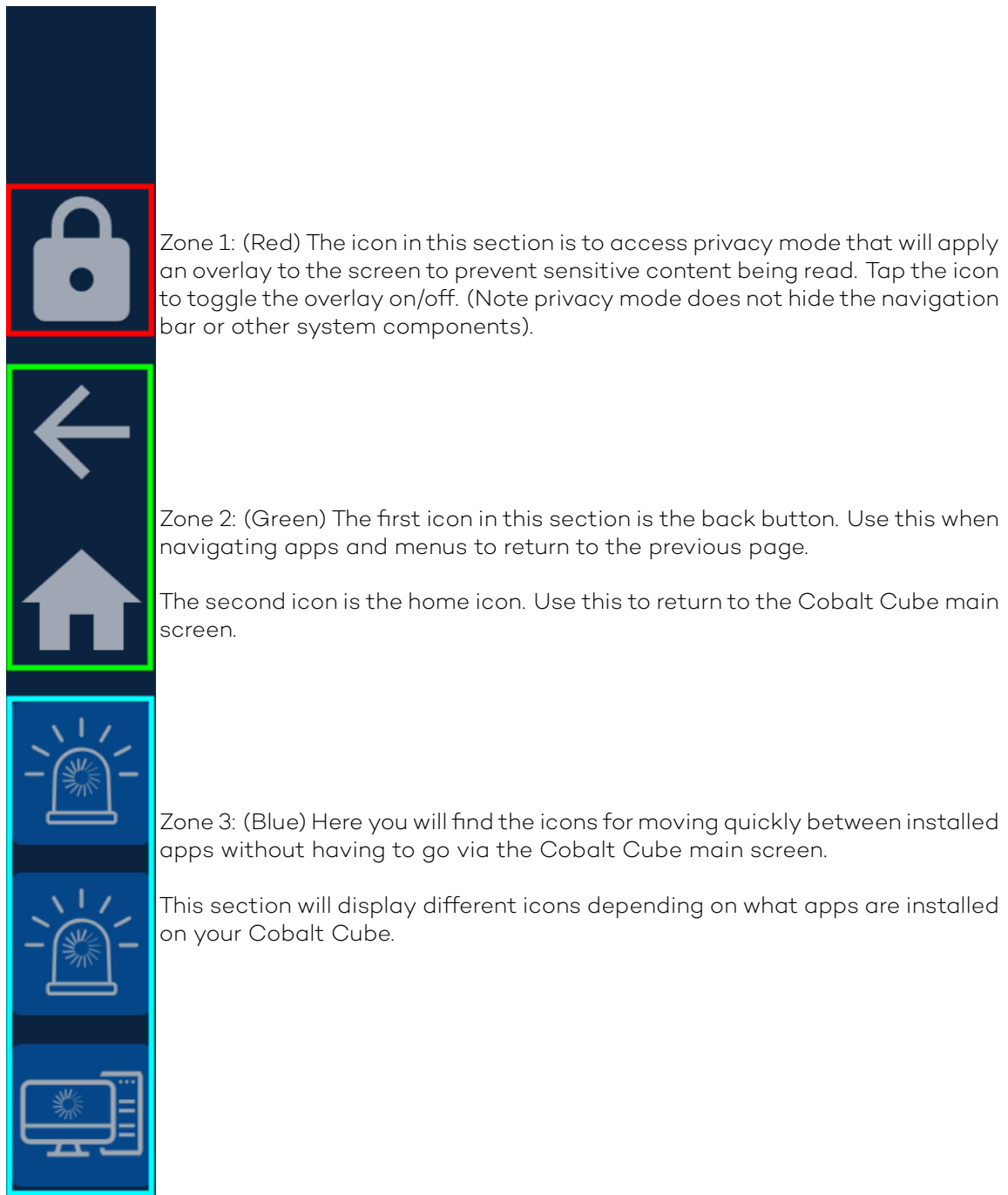

Figure 12: App name customisation

Note: The name of the Logging App will always be “Dump Logs” in the Cobalt Cube Launcher. This reflects the functionality of the app when shown in the launcher.

4.5 Navigation bar

The Cobalt Cube features a navigation bar that is divided into three zones:



4.5.1 Position

The Cobalt Cube navigation bar can be configured in four possible ways. By default, the navigation bar is present on the left side of the screen. When changing the position of the navigation bar the following list of four options will be shown as in Figure 13.

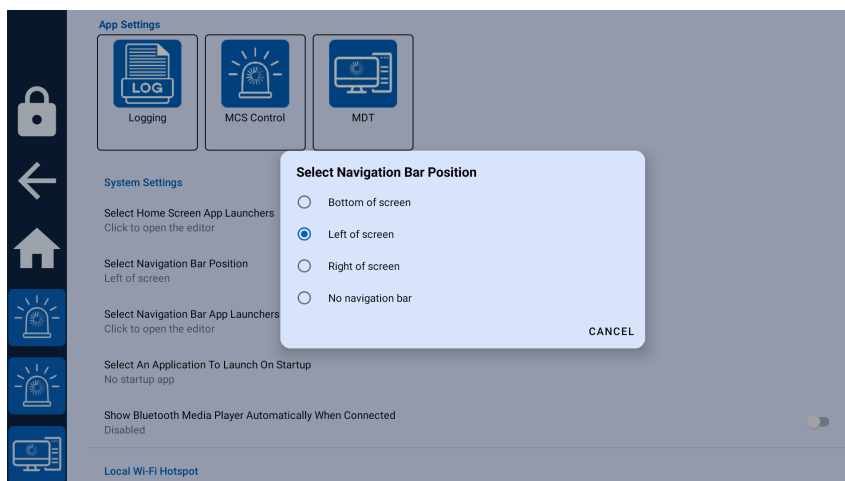

Figure 13: Navigation bar position dialog

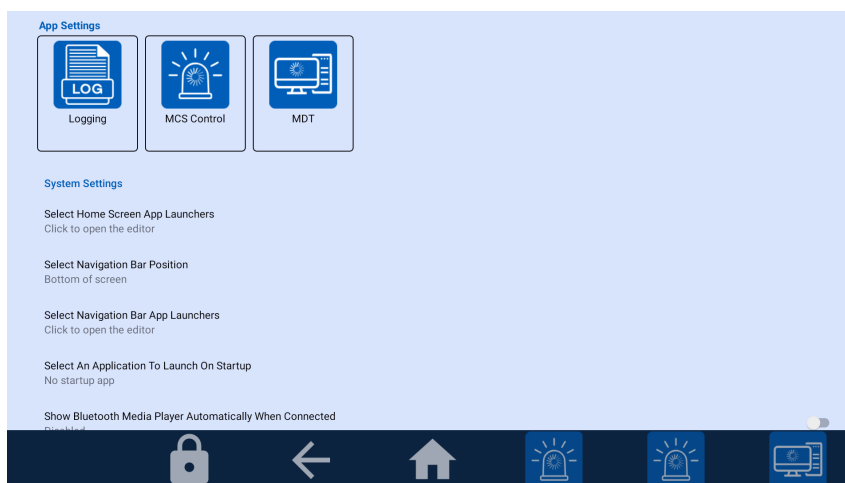

Figure 14: Navigation bar at the bottom of the screen

Note: Only applications preinstalled by VNC Automotive on the Cobalt Cube are guaranteed to be navigable when the navigation bar is hidden (done by selecting “No Navigation Bar” in the options). As such, we recommend that you keep the navigation bar visible and only turn it off if you have a specific reason to do so. Furthermore, when setting up your Cobalt Cube, disabling the navigation bar should be the last step you perform.

Note: If you choose to hide the navigation bar then navigation bar specific functionality such as “privacy mode” will be unavailable.

4.5.2 Navigation bar quick launch apps

There are three spaces for app launchers in the navigation bar. By default, these are populated by VNC Automotive applications. They can be changed by clicking “Select Navigation Bar App Launchers”. A dialog will appear showing the apps currently in the navigation bar as well as the apps that could be added to it. Apps that are not currently in the navigation bar are greyed out. Tap the greyed-out app icons in the dialog to add them to the navigation bar, and the non-greyed-out icons to remove them.

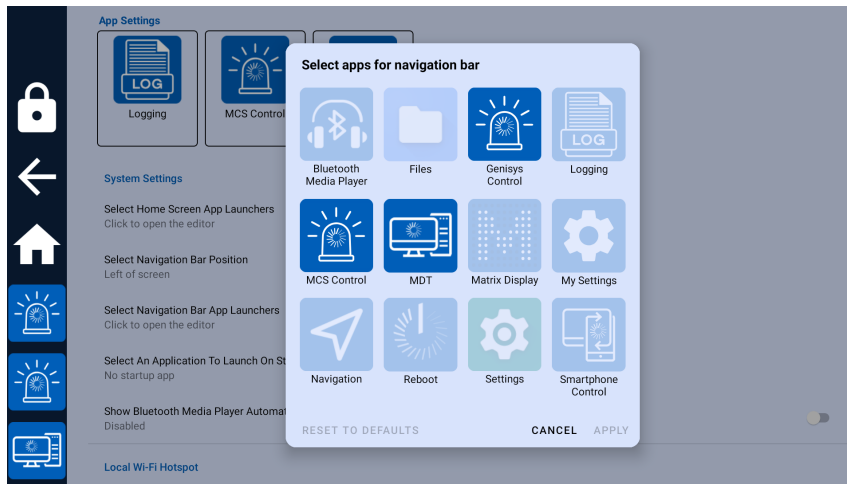

Figure 15: Navigation bar application picker

Note: The order in which apps are added to the navigation bar affects the order in which they are displayed.

4.6 Setting up the home screen

By default, the home screen is set up with all installed VNC Automotive applications listed in alphabetical order, except for Bluetooth Media Player. App launchers can be added or removed from the home screen by clicking the “Select Home Screen App Launchers” option. A dialog will appear with icons representing the apps that can be added to the home screen, which are greyed out, as well as apps that are already shown on the home screen, which are not greyed out. This dialog behaves in a similar way to the dialog for changing the apps in the navigation bar. Click the app icons in the dialog to select or deselect them. Selected apps will appear in the home screen once the changes are applied.

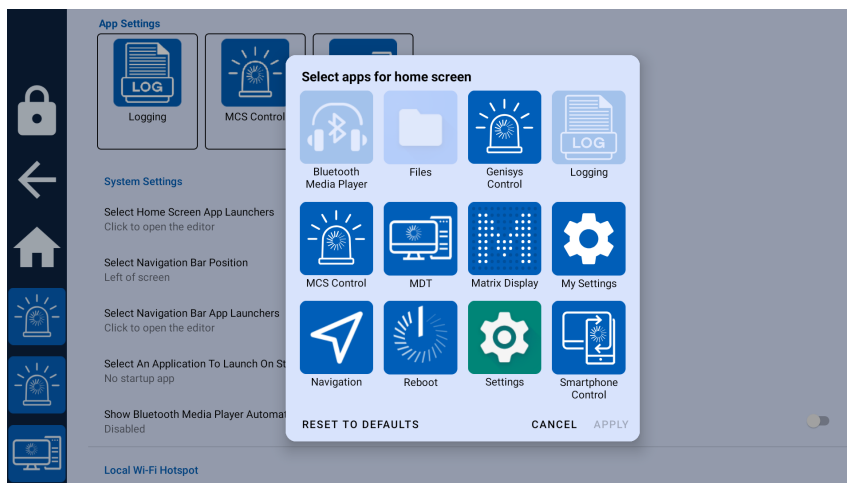

Figure 16: Home screen application picker

Note: By default, the System Settings application is hidden. You will need to enable it through this menu to access features like Bluetooth and Wi-Fi settings.

4.7 Setting a startup application

If there is an application that should open on startup, it can be selected in the “Select an application to launch on Startup” menu. By default, this is set to MDT if it is installed, otherwise it is set to “No startup app”.

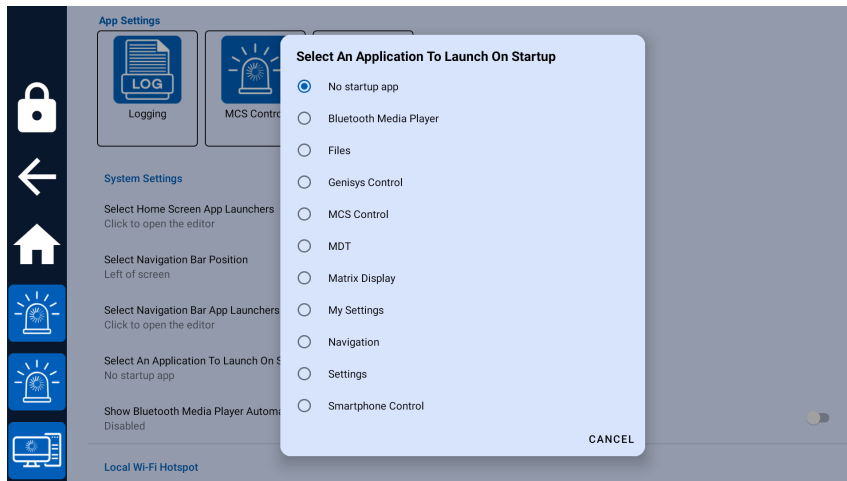

Figure 17: Startup application picker

Note: only apps shown on the home screen will appear in this menu. If an app is missing from this menu, add it to the home screen.

4.8 Setting a custom Network Time Protocol (NTP) server

The Cobalt Cube supports user defined NTP servers. Initially, three things need to be done before the custom NTP server will be enabled. First, the custom NTP server toggle under “Use Custom NTP Server” must be toggled on. Second, the “NTP server address” must be set to the desired IP address or domain name as seen in Figure 18. After both these steps are complete, the Cobalt Cube must be rebooted for the changes to take effect.

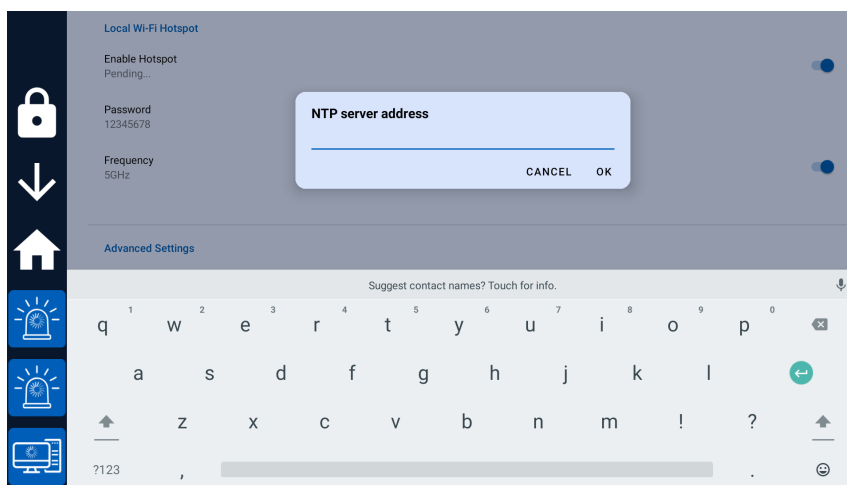

Figure 18: Choose custom NTP address

To disable the use of a custom NTP server the “Use Custom NTP Server” should be toggled off and the Cobalt Cube rebooted. There is no need to clear the address saved in “NTP server address” when disabling the custom NTP server. If an address is already present in “NTP server address” when “Use Custom NTP Server” is toggled on, then it will be applied after the subsequent reboot. When either the toggle is changed, or the address entered a prompt will show as in Figure 19. This shows the following options: “CANCEL CHANGES” which stops that change from being applied and returns you to the settings, “REBOOT LATER” will save the change so it will be applied on any later reboot and “REBOOT NOW” which immediately reboots and applies the change.

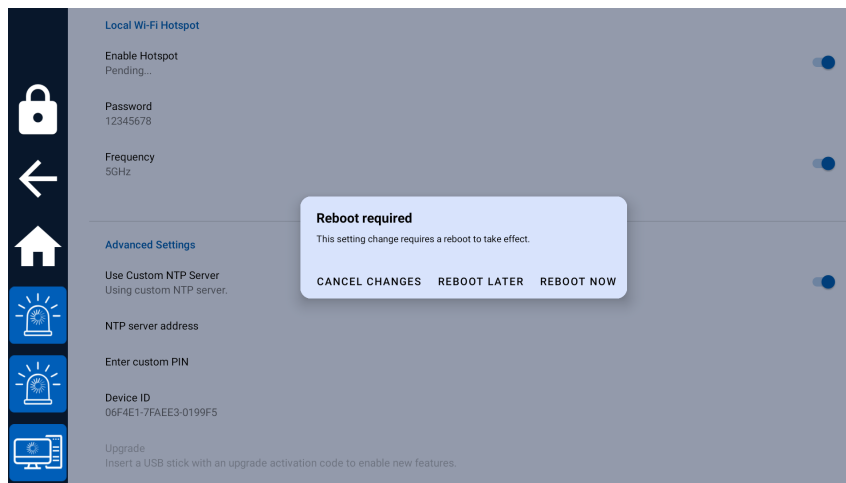

Figure 19: NTP reboot prompt

Note: The Cobalt Cube polls the custom NTP server once a minute. This allows the use of the server as a source of time-zone adjusted time, where large jumps are possible.

4.9 Phone call support

While the Cobalt Cube is connected to an IVI Display, a mobile phone handset can also be connected to the vehicle's head unit via Bluetooth. This allows call audio to be handled through the vehicle's speakers and microphones. For the widest compatibility with different vehicles and mobile phone handsets, Cobalt Cube has been designed to work alongside the pre-existing Bluetooth hands-free phone call support of the vehicle. For Cobalt Cube to run alongside a paired handset in the vehicle, a one-time setup process is required.

Note: Control over the call (making a call/picking up a call etc...) is dependent on the vehicle's IVI system and varies from vehicle to vehicle. Some controls in some vehicles may be disabled whilst Android Auto is active. One or more of voice command, steering wheel buttons, head-up display controls and central console controls may or may not be possible in your vehicle whilst Cobalt Cube is connected. When integrating Cobalt Cube in a new vehicle it may be instructive to run test calls and identify the supported functions for phone call handling.

4.9.1 Setup

The following steps should be followed to set up phone call support.

Step 1 - Link the phone to the Cobalt Cube

The first step is to link the phone with the Cobalt Cube. To do this the phone must have its Bluetooth turned on and be discoverable. Open "My Settings" and click "Selected Bluetooth handset" under the category of "Phone Settings". This brings up a pop up which shows all discoverable Bluetooth devices within range of the Cobalt Cube, select the phone you would like to use (as seen in Figure 20).

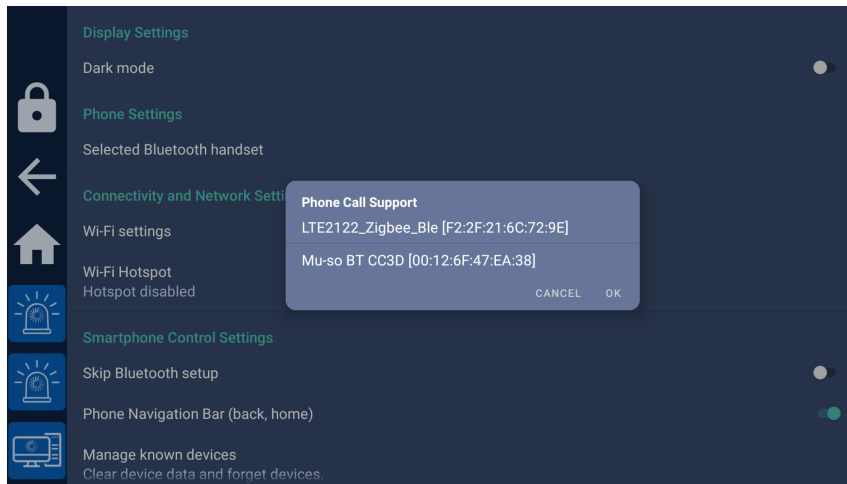

Figure 20: Linking a phone to the Cobalt Cube

Click “OK” to select the device that will be linked to the Cobalt Cube. To complete the linking procedure, the Cobalt Cube will need to be restarted. A pop-up will appear allowing an immediate reboot or a deferred reboot (see Figure 21). If the reboot is deferred, then the “Reboot” app will need to be used to reboot the Cobalt Cube before moving on to the next step.

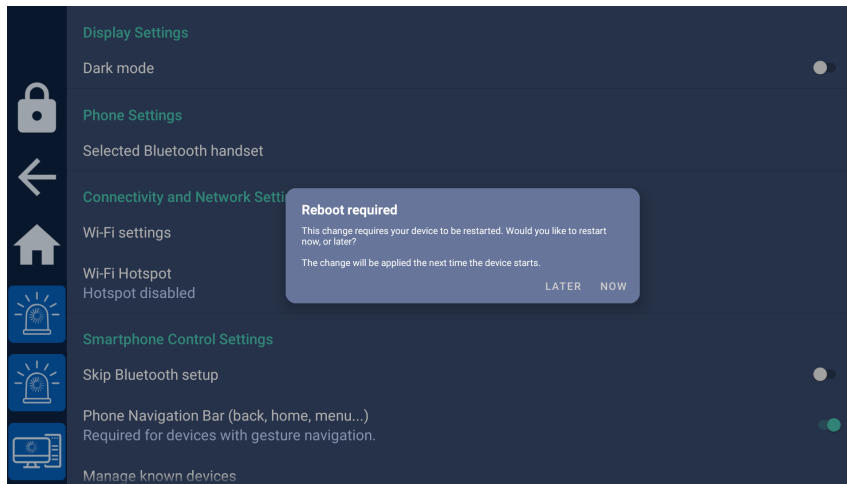

Figure 21: Post linking reboot prompt

Step 2 - Pair and connect the phone to the vehicle

If the specified phone is already paired and connected to the vehicle, then this step can be skipped. If not, the phone needs to be paired and connected to the vehicle through Bluetooth. Ensure that the vehicle is selected as the device used for phone calls. Once this is done, all phone call audio will be route through the vehicle.

Note: In a small number of vehicles, it has been observed that pairing cannot be done while the Cobalt Cube is connected, in this case, restart the Cobalt Cube and pair the phone while it is rebooting.

4.10 Bluetooth Audio

The Cobalt Cube can act as a bridge between a Bluetooth capable device and the vehicle, enabling the audio from the device to be played through the vehicle’s speakers.

4.10.1 Setup

The following steps need to be followed to enable the use of Bluetooth audio through the Cobalt Cube.

First the device must be paired with the Cobalt Cube. To do this, the device must have its Bluetooth turned on and be discoverable. The device and the Cobalt Cube can be paired through the “Settings” app (this can be shown on the home screen by following the instructions in section 4.6). To do this, open “Settings” and go through the following menus: “Connected devices” → “Pair new device”. Then select your device and follow the instructions on the prompt. After the devices are paired, ensure that media audio is enabled for your device by opening the “Settings” app and selecting “Connected devices” → your device. The “Media audio” setting should be enabled as in Figure 22. If it is not, toggle the option so that it is enabled for this device.

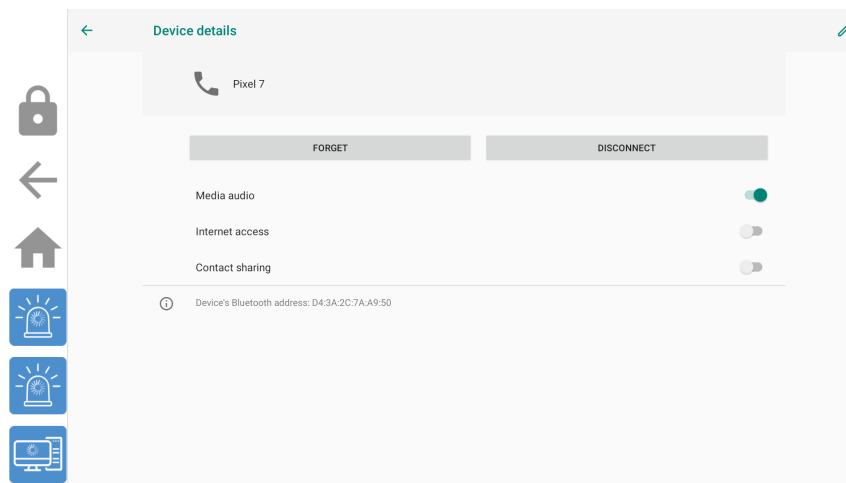

Figure 22: A Bluetooth device with Media audio enabled

Note: Multiple Bluetooth devices can be connected to the Cobalt Cube at once, however, only one should be enabled for media audio at a time as there is no way to select which one will be used.

4.10.2 Bluetooth Media Player

When another device is connected to the Cube and playing media audio, this audio can be controlled using the Bluetooth Media Player app on the Cobalt Cube. There are three ways to access the Bluetooth Media Player:

- Add the Bluetooth Media Player to the home screen (see section 4.6 for more details) and open the app as normal.
- Enable “Show Bluetooth Media Player Automatically When Connected” as seen in Figure 11 which will launch the media player when a Bluetooth media device is connected.
- Open it from the volume control bar by clicking the Bluetooth icon in the volume control bar (see Figure 23). The volume control bar is shown when the volume is changed on the Bluetooth media device.

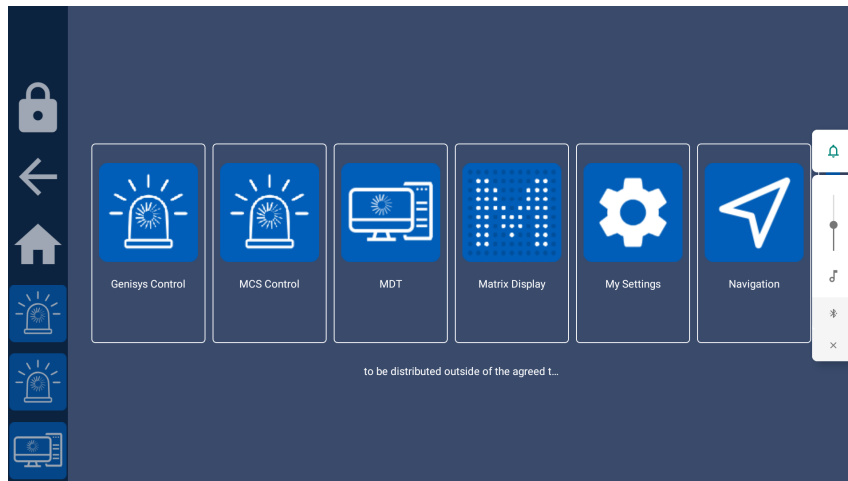

Figure 23: The volume control bar

The Bluetooth Media Player has two modes:

- Full-screen mode: Where the media player covers most of the screen, see Figure 24.
- Overlay mode: This is a smaller overlay at the top of the screen, see Figure 25.

Switching between these modes can be achieved by clicking the plus or minus buttons on the right-hand side of the Bluetooth Media Player, and it can be closed by clicking the adjacent "X" icon.

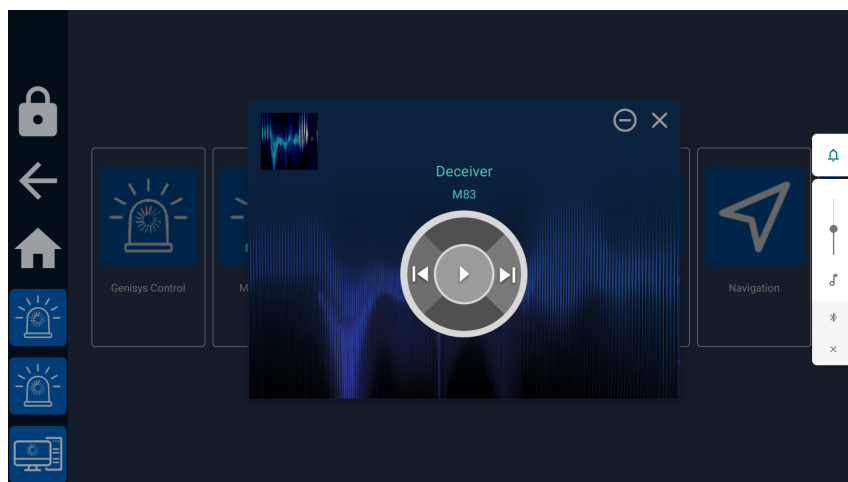

Figure 24: The Full-screen media player

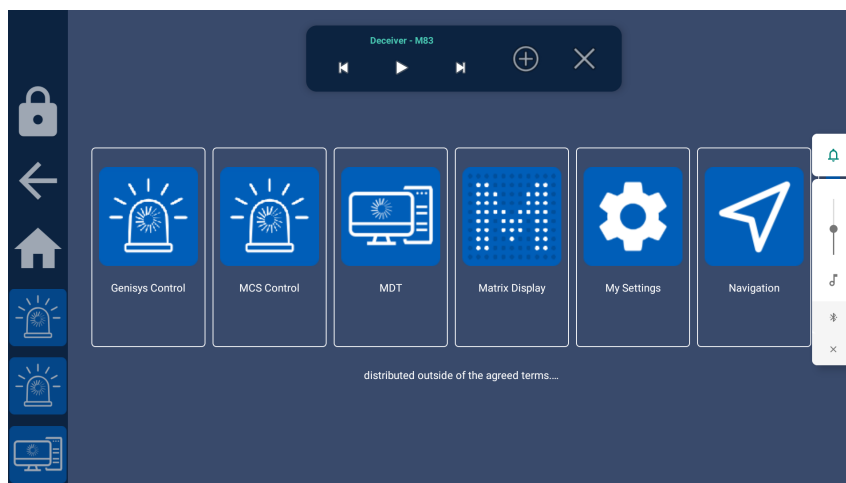

Figure 25: The media player in overlay mode

The play/pause, next and previous buttons can be used to control the media audio from the Cobalt Cube. However, these controls will not work for non-media audio such as navigation directions.

4.10.3 Bluetooth Automatic Reconnect

The Cobalt Cube is able to automatically reconnect to any Bluetooth devices that it has previously been connected to. It will do this for 5 minutes after it boots, or until it successfully connects to a device, whichever is sooner. This means that a device that is paired with the Cobalt Cube and within Bluetooth range will automatically connect when the Cobalt Cube boots, without requiring any user intervention.

If, after the 5 minutes has passed, the Cobalt Cube has not been able to connect to any Bluetooth devices, it will stop attempting to connect automatically. In this case a Bluetooth connection will need to be manually initiated from either the Cobalt Cube or the other device by the user.

5 Updating the system image

The Cobalt Cube system can be updated easily and updates including security, compatibility and/or feature updates will be routinely provided during the lifetime of your product. For this you will only need a thumb drive and an update file provided by VNC Automotive.

Note: We recommend having an HDMI monitor connected to the Cobalt Cube while updating to allow you to monitor the progress of the update. While the update is in progress there will be nothing displayed through the car connection.

Warning: You must not remove the USB stick from the Cobalt Cube or interrupt the power while the device is being updated. If this happens it may render the device unusable and it will have to be returned to VNC Automotive.

Follow these steps to apply the update:

1. Rename the update file provided by VNC Automotive to update.zip.
2. Copy the update file into the root directory of the USB thumb drive.
3. Insert the USB thumb drive into the Cobalt Cube HOST port.
4. After a few seconds, a dialog will pop up, notifying that an update has been found on the USB drive (see Figure 26). Select "Install" to install it.
5. The Cobalt Cube will install the update, and automatically reboot in the process. This may take a few minutes, do not remove the thumb drive or power off the Cobalt Cube until the process is completed.

Note: if the update process appears to be stuck on a black screen, press the reboot button on the Cobalt Cube. The button can be found on the same side as the HDMI port.

The Cobalt Cube will automatically display a dialog notifying of the successful update after it has been rebooted, and asking the user whether they want to delete the update file from the USB thumb drive, to prevent the process from starting again (see Figure 27). At this point it is safe to extract the USB thumb drive. Keeping the thumb drive plugged and not deleting the update.zip file when prompted may cause the Cobalt Cube to offer to update again.

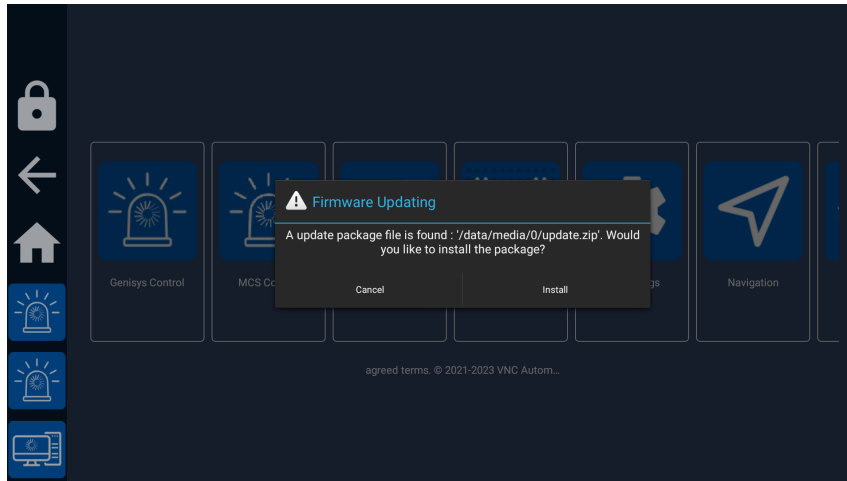

Figure 26: Update dialog

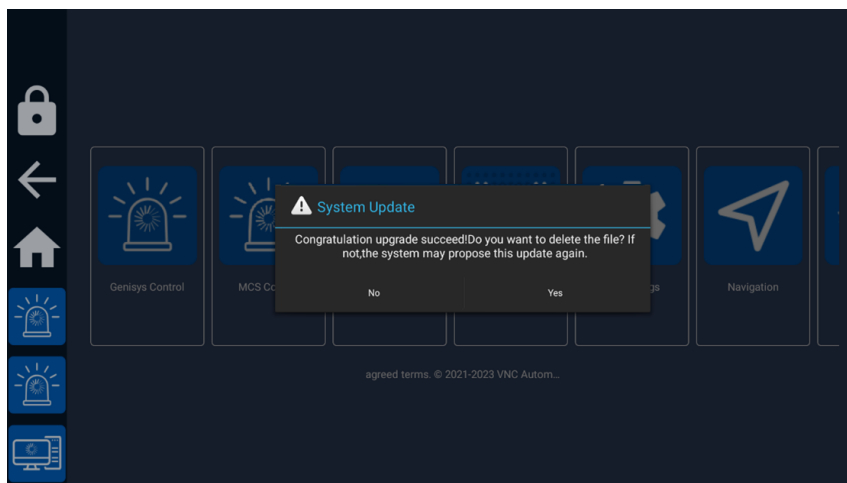

Figure 27: "Update successful" dialog

5.1 Rebooting the Cobalt Cube

In order to reboot the Cobalt Cube from the IVI screen, the Reboot app can be used. Clicking on the app opens a simple prompt as shown in Figure 28. Clicking "OK" on this will immediately reboot the Cobalt Cube, whereas selecting "CANCEL" will close the prompt and not reboot.

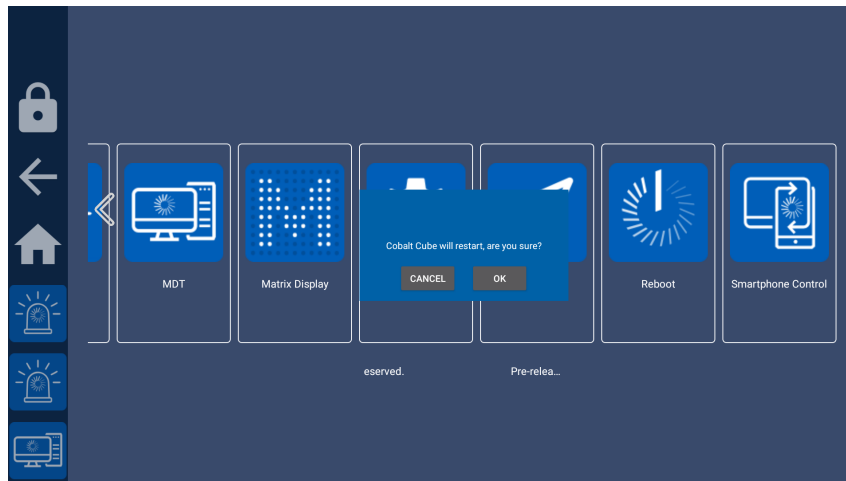

Figure 28: Cobalt Cube reboot prompt

5.2 Activating new features

If new apps or features have been purchased, they can be activated using the “Upgrade” option in hidden settings, under the “Advanced Settings” section. This is shown in Figure 29. To enable the option, a storage device with an activation code should be inserted into the “HOST” port.

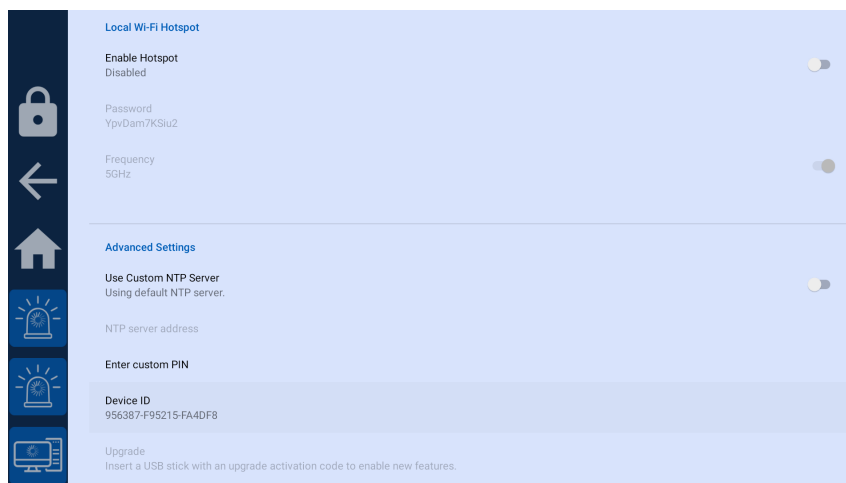

Figure 29: Upgrade option with no storage device inserted

When enabled, the upgrade option should appear as in Figure 30.

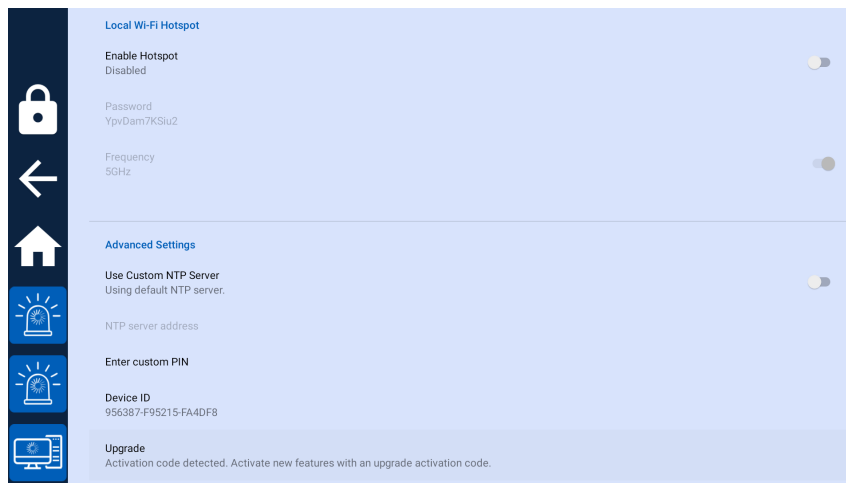

Figure 30: Upgrade option with activation code detected

Click the upgrade option to open the dialog shown in Figure 31. This should list the activation codes detected on the storage device. This will usually be only one. When the correct activation code is selected, click “UPGRADE”. This will apply the upgrade and activate any new purchased features.

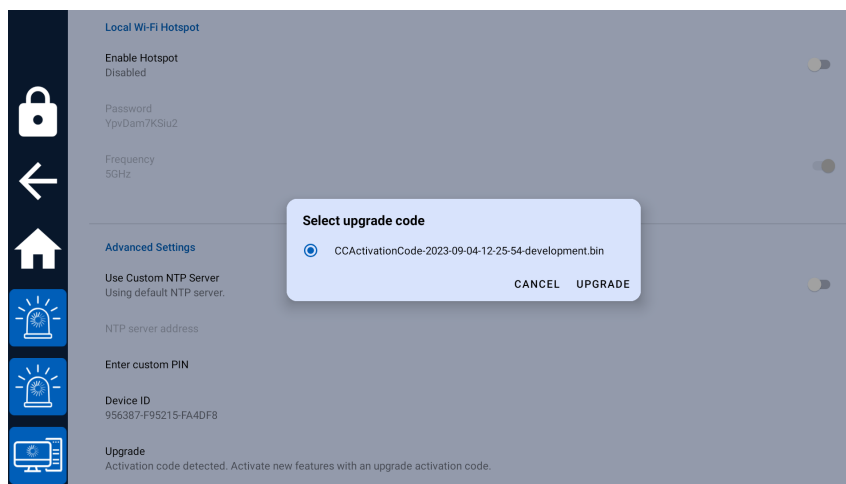

Figure 31: Upgrade option with activation code detected

Settings can also be applied in this step, to go along with any features that are activated.

6 Use case: MCS Control

6.1 Introduction

The MCS Control application is designed to work with MCS hardware and firmware from Standby® RSG, such as the MCS-32, MCS-16 and MCS-8.

The Cobalt Cube works in harmony with the existing MCS configuration tool from Standby® (see Figure 32). Each MCS is configured as before to have the desired handsets, inputs and outputs, via the Windows configuration tool provided by Standby®. The Cobalt Cube MCS Control application works by reflecting the existing handset configuration of each MCS. On application start, the software reads the handset configuration, via the USB-serial interface, and reflects the instantaneous state of each handset button and shows this on the equivalent User Interface (UI). This button state includes the button colour set for its on and off states and also if it is currently illuminated.

6.2 Additional hardware requirements

Apart from the Cobalt Cube, the following hardware is required:

- Standby® MCS unit.
- Standby® MCS CAN Bridge (includes USB cable to connect to the Cobalt Cube).
- MCS handset (optional).

6.3 Connectivity instructions

Figure 32 shows the connections between the Cobalt Cube, MCS components, and IVI system screen.

1. Connect the MCS Controller to the MCS CAN Bridge via the included cable, plugging into the local CAN port of the MCS.
2. Connect the Cobalt Cube to the MCS CAN Bridge, via the USB-A cable included with the MCS CAN Bridge. Use the USB Host port on the Cobalt Cube.
3. If required, connect the MCS Handset to the MCS CAN Bridge, via the adapter provided.
4. Connect the Cobalt Cube to the IVI screen, via the USB OTG port on the Cobalt Cube. A USB-A to USB-C cable is required for this connection.

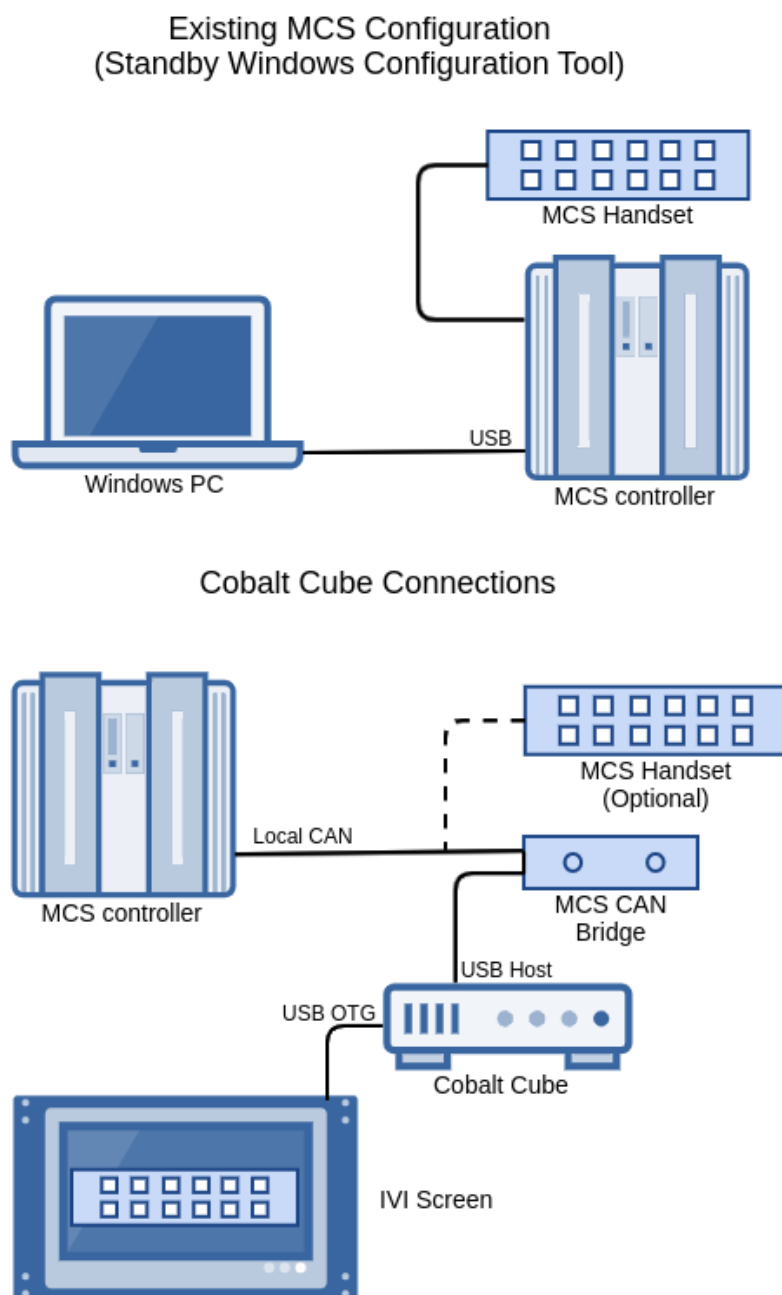

Figure 32: MCS Control connectivity diagram

6.4 Working with the MCS Control app

The MCS Control application can be run by tapping the “MCS Control” application icon from the Cobalt Cube app launcher screen, which appears on the IVI screen.

The UI for the handset can be individually tailored for your use case. For more information, please contact your VNC Automotive representative.

The following screenshots, for a typical T-16 handset, are provided as an example. Please note that the colours are for illustration purposes only, and in a real system would reflect the colours set in the MCS. Each button can be pressed on the vehicle’s IVI screen to operate the MCS in the same way that is done on the hardware handset. This operation happens with or without the hardware handset present in the vehicle.



Figure 33: Example UI (no buttons pressed)



Figure 34: Example UI (some buttons pressed)

Tapping the back arrow at the top left takes the user back to the Cobalt Cube app launcher screen.

Please note that if the MCS is not connected to the Cobalt Cube via the USB-CAN bridge, the following error will be shown:

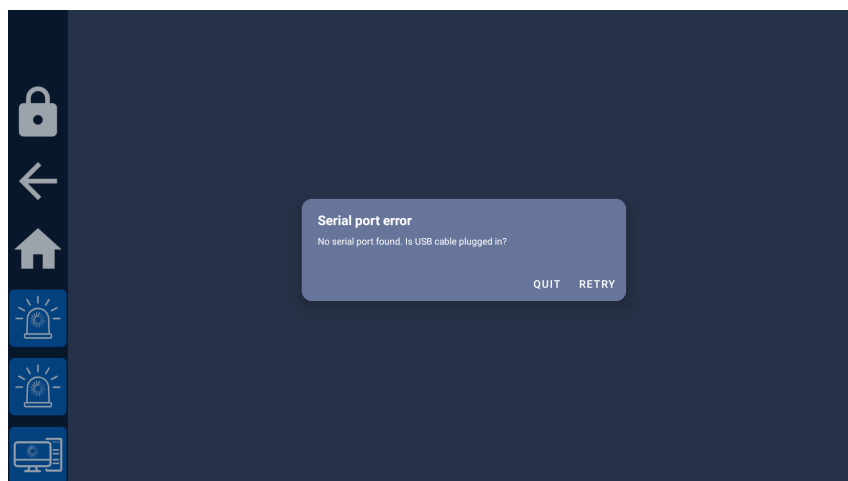

Figure 35: Error message when the MCS CAN Bridge USB cable is unplugged

In this case, check the USB Host port has the MCS CAN Bridge USB cable plugged in and tap “RETRY”. Tapping “QUIT” exits to the Cobalt Cube app launcher screen.

6.5 Configuring the MCS Control application

There is a configuration file for the MCS buttons at `/vnc/mcscontrol/`. The directory for the configuration will be created upon the launch of the main app or upon launch of the settings activity.

The MCS app will look for any file in the configuration directory that ends with a “.config” extension. If there is more than one file with that extension it will pick one to load. In this case the file is chosen arbitrarily in whatever order they are discovered by the application. You should not rely on this behaviour.

It is recommended that only a single configuration file called `mcs.config` is present in the configuration directory at any one time.

The file is a csv file with the following layout:

```
<Handset ID>,<Button ID>,<Grid ID>,<Grid Position>,<Button Text>
```

Name	Possible Values	Description
Handset ID	0 - 127 inclusive	This is the value for the handset id. This is typically 0.
ButtonID	0 - 127 inclusive	The ID of a specific button as configured in the MCS.
Grid ID	0 or 1	Specify if the button should be in the left grid of square buttons (0) or the right grid of rectangular buttons (1).
Grid Position	Grid ID 0: 0-11 inclusive. Grid ID 1: 0-1 inclusive.	The position in a grid that the button should be displayed. Indices start at the top left of a grid.
Button Text	Any text but must not contain a comma character.	The text to be displayed on the button.

If no configuration is specified, the application will use the following default preset:

```
0,15,0,0,Screen\nOn/Off
```

```
0,13,0,1,Inten\n-sity
```

```
0,11,0,2,Light\nBar
```

```
0,9,0,3,Run\nLock
```

```
0,7,0,4,Wing\nBlue
```

```
0,5,0,5,Siren\nOn/Off
```

```
0,14,0,6,Screen\nToggle
```

```
0,12,0,7,Rear\nReds
```

```
0,10,0,8,Cruise
```

```
0,8,0,9,H/L\nFlash
```

```
0,6,0,10,PTT\nPA
```

0,4,0,11,Siren\nToggle

0,2,1,0,9\n9\n9

0,0,1,1,PTT\nTetra

Configuration of these values is possible through the MCS settings application. See section 4.3 for details on how to access this.

Each row in the configuration file is represented by a row in the configuration application. Buttons can be modified, added and removed.

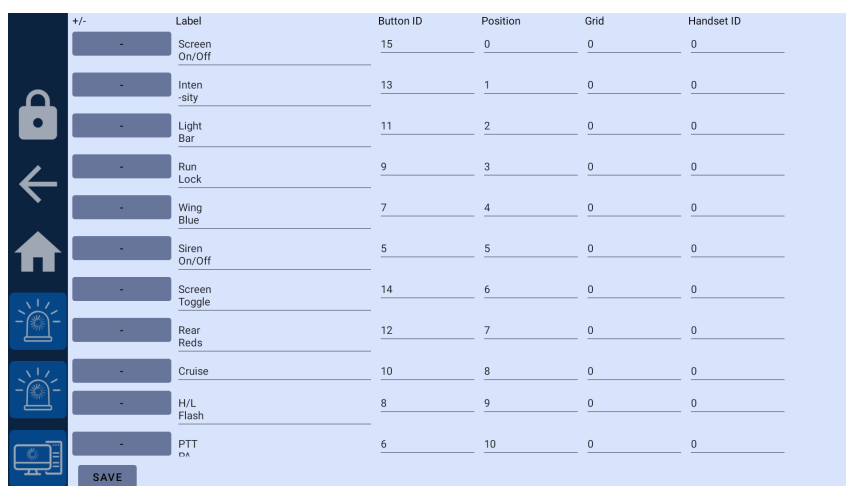

+/-	Label	Button ID	Position	Grid	Handset ID
-	Screen On/Off	15	0	0	0
-	Intensity	13	1	0	0
-	Light Bar	11	2	0	0
-	Run Lock	9	3	0	0
-	Wing Blue	7	4	0	0
-	Siren On/Off	5	5	0	0
-	Screen Toggle	14	6	0	0
-	Rear Reds	12	7	0	0
-	Cruise	10	8	0	0
-	H/L Flash	8	9	0	0
-	PTT PA	6	10	0	0

Figure 36: The configuration menu for the MCS Control app

7 Use case: MDT (Mobile Data Terminal) Control

7.1 Introduction

The MDT application is designed to connect with and control software running on a separate PC, laptop or tablet running Microsoft Windows. Different Cobalt Cube users in different first response scenarios can access essential applications such as Automatic Number Plate (License Plate) Recognition System (ANPR) software, or secure messaging and command control systems.

The Windows machine needs a compatible Cobalt Link+ server and to be on the same IP network.

Please refer to the Getting Started Guide for the Cobalt Link+ server for Windows for more information on how to set up Cobalt Link+ in the Windows machine.

Note: the MDT application can be renamed as appropriate to better match the function of the controlled Windows PC, which can make finding the right application to launch from the main list even easier for the user when in-vehicle. See section 4.4.

7.2 Additional hardware requirements

Apart from the Cobalt Cube, the following hardware is required:

- Windows PC running a Cobalt Link+ server.
- Router (wired or wireless).
- 2x Ethernet cables (only one is mandatory).

7.3 Connectivity instructions (Router)

There must be a network to which both the Windows PC and the Cobalt Cube are connected. The Cobalt Cube should be connected using an Ethernet cable (from its ETHERNET port) to the router; the Windows PC can be connected over Ethernet or Wi-Fi.

7.4 Connectivity instructions (Direct)

It is possible to connect the Cobalt Cube to the Windows PC directly without the need for a router if required. In order to facilitate this, both the Cobalt Cube and the Windows PC will require a static IP address in the same range. E.g. 192.168.1.10 for the Cobalt Cube and 192.168.1.20 for the Windows PC.

7.5 Assign static IP address for Ethernet adapter Cobalt Cube

On the Cobalt Cube, navigate to:

Settings > Network & Internet > Advanced > Ethernet > Ethernet Ip mode > static

You will then be prompted to enter your desired network settings.

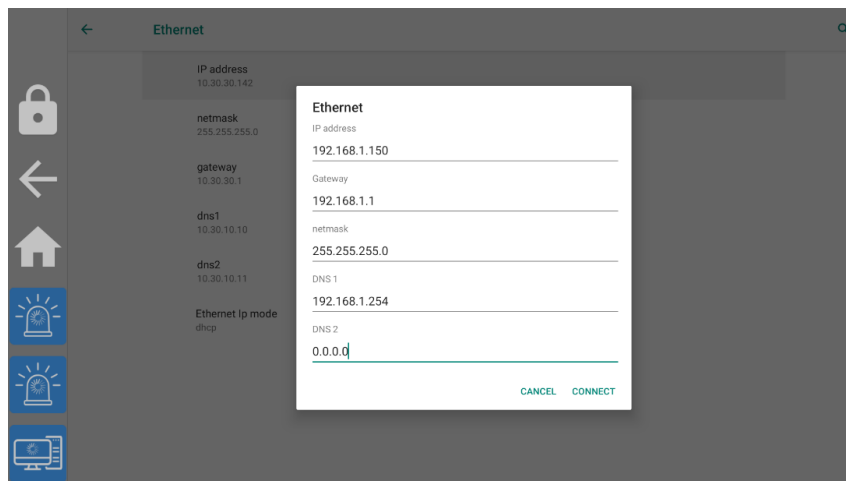

Figure 37: Cobalt Cube static Ethernet settings

When setting a static IP address on the Cobalt Cube, the Android system populates the entries with an example in grey text. These values are for guidance only and need to be re-entered manually, at which point they will show up as black text, as shown in Figure 37.

The “Connect” button will stay greyed out until each of the required entries has been entered.

7.6 Assign static IP address for Ethernet adapter Windows PC

From the desktop navigate to:

Settings > Network & Internet > Change adapter options

Right click on the active Ethernet Adapter and select:

Properties > Internet Protocol Version 4 (TCP/IP) > Properties > Use the following IP address

You may then enter the desired network settings.

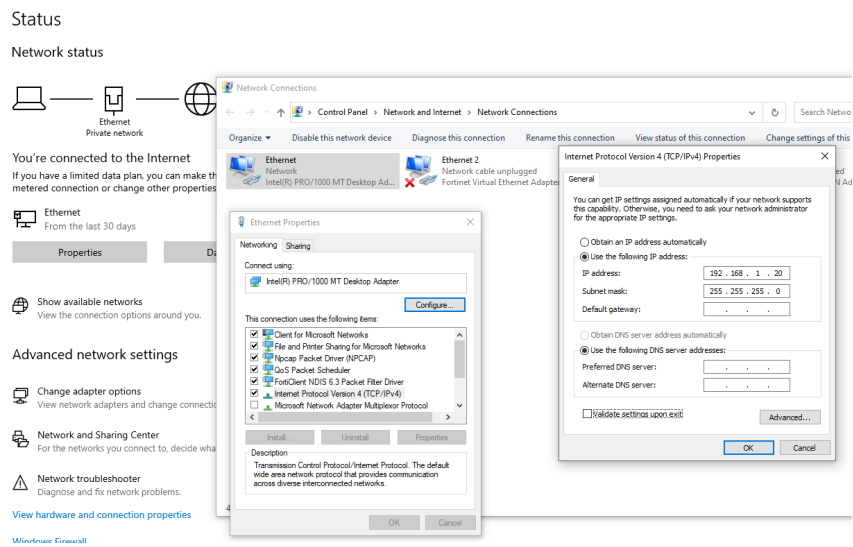

Figure 38: Windows PC static Ethernet settings

7.7 Working with the MDT application

After launching the application from the Cobalt Cube launcher by tapping the “MDT” icon, you’ll be presented with the following screen, and a connection will start automatically:

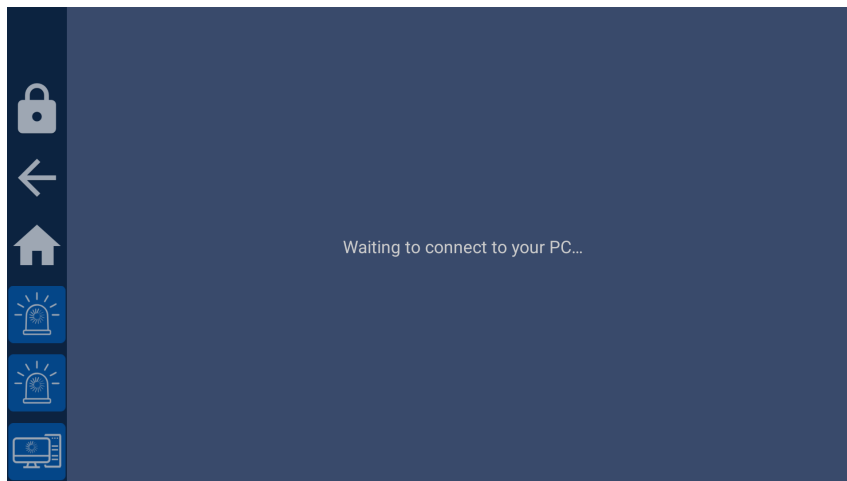

Figure 39: MDT Control screen

Once the connection is started, the Windows machine screen will be displayed on the Cobalt Cube, as shown in these examples:

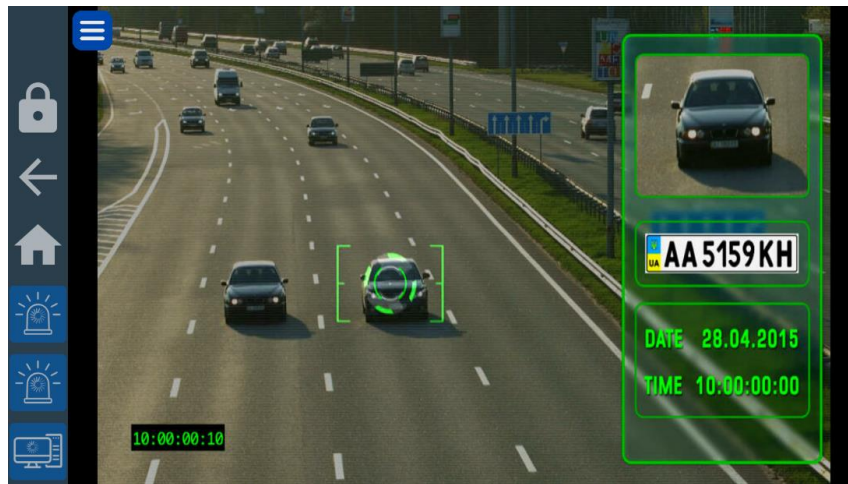

Figure 40: Example of projected MDT Control software

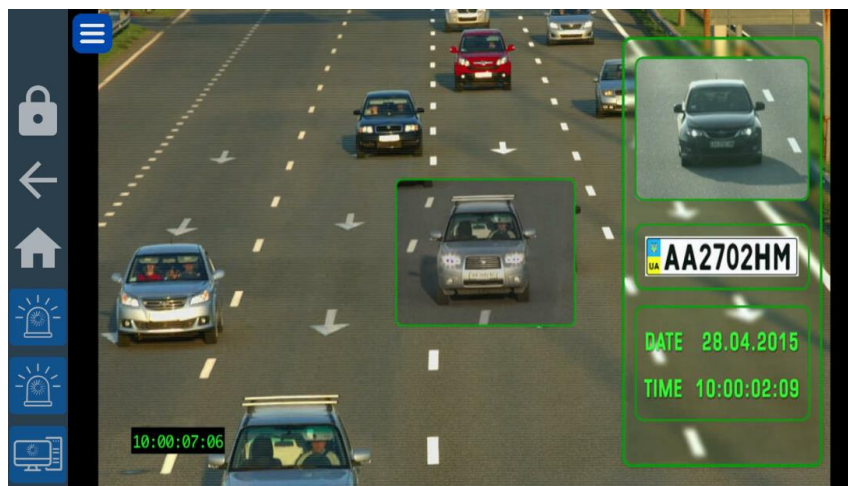

Figure 41: Example of projected MDT Control software

7.8 MDT configuration

The MDT application supports several configuration options via a file located at:

```
/vnc/anprcontrol/config.properties
```

Configuration options in this file are formatted using `<name>=<value>` syntax and are separated by new lines. E.g.:

```
scalingFactor=1  
hideMenuBackButton=true
```

The full list of supported options is:

Name	Possible Values	Description
commandstring	<p>Any valid VNC Automotive command string.</p> <p>For connecting to a listening server:</p> <pre>vnccmd:v=1;t=C;a=<server-ip>;p=<server-port></pre> <p>For listening for an incoming connection:</p> <pre>vnccmd:v=1;t=L;p=<listening-port></pre>	<p>This value may be used to override the default behaviour of the MDT viewer and direct it to connect to a specific server or to listen for incoming connections.</p>
hideMenuBackButton	"true" or "false"	<p>If true, the floating back menu button will not be displayed in the application.</p> <p>Defaults to false.</p>
scalingFactor	Decimal values ≥ 1.0	<p>Controls the scaling factor applied to the captured desktop before it is transmitted by the Cobalt Link+ Server.</p> <p>The scaling factor can be useful to save network bandwidth when using a smaller screen where a high resolution is not required.</p> <p>Note: captured desktops can only be downscaled at this time.</p> <p>Defaults to 1.0.</p>
encoding	<p>Must be one of:</p> <p>RAW JPEG TRLE</p>	<p>Selects the encoding used by the Cobalt Link+ Server.</p> <p>Defaults to JPEG</p>
fitToScreen	"true" or "false"	<p>Controls if the Cobalt Cube will attempt to stretch the frame data to fill the available display space.</p> <p>Defaults to true.</p>
setServerDisplayResize	"true" or "false"	<p>If true, the Windows desktop aspect ratio is changed to better match the head unit, to provide higher image quality.</p> <p>Defaults to false.</p>

Note: It is possible through the combination of turning off the navigation bar in the Cobalt Cube settings and setting "hideMenuBackButton" to true to have no button to exit MDT if it is actively connected. This can be desirable to maximise the amount of screen space

available for the MDT application and to prevent accidental clicks outside of the app.

However, to exit the app, the connection to the Cobalt Link+ Windows Server must be closed. Once the connection has ended the application can then be exited from the discovery screen via the back button in the top bar.

These settings can be changed using the configuration tool that can be accessed through the Cobalt Cube settings menu. For details on how to do this, see section 4.3.

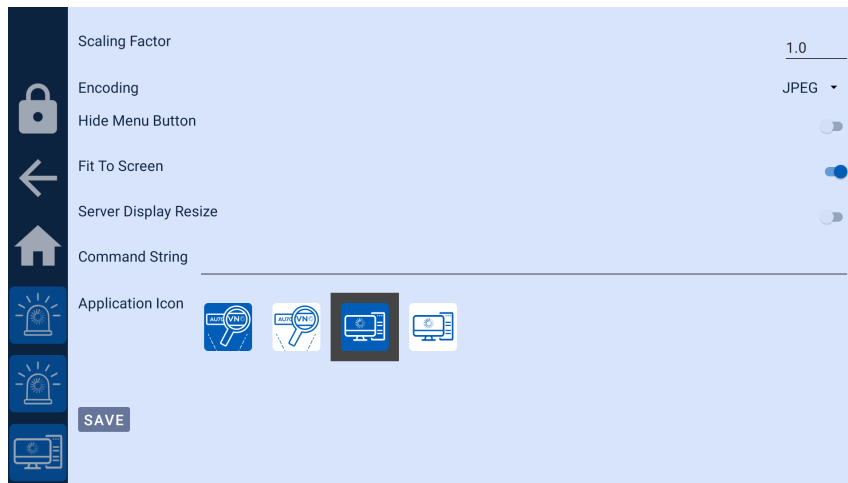

Figure 42: Cobalt Cube Settings -> MDT

To create the configuration file manually, you will require the use of another computer. On that system create the file config.properties and add the desired options.

Copy the file config.properties to a USB memory stick and transfer that USB memory stick to the Cobalt Cube.

On the Cobalt Cube, select the “File Explorer” option in the “Select Apps” menu (See section 4.6). This will add the file browser application to the home screen.

Note: When you have finished, remember to hide the file browser application if it is not suitable for end users.

Open the Files application and select the three dots in the top right corner to access the menu. Choose “Show internal storage” from the options.

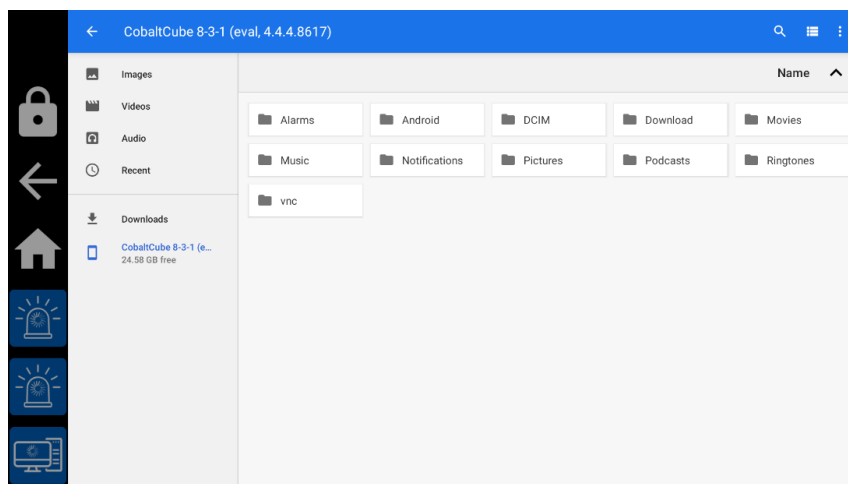

Figure 43: Files app showing internal storage and memory stick

Using the three-dot menu, create the directory structure `/vnc/anprcontrol` if it doesn't exist.

Copy the `anpr.properties` file from the memory stick to `/vnc/anprcontrol`. It is important that there is only a single file in this directory to avoid ambiguity over which configuration file MDT is using.

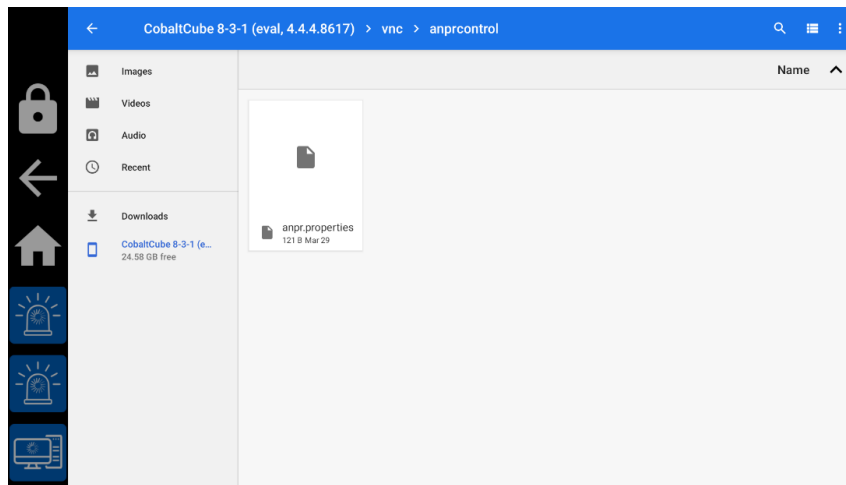

Figure 44: Files app showing the MDT configuration file

Remove the memory stick and return to the home screen.

8 Use case: Smartphone Control

8.1 Introduction

The Smartphone Control app is designed to be used in conjunction with iOS and Android devices that have the Cobalt Link+ app installed. This connection will allow you to view and control the apps running on your mobile device from the Cobalt Cube. For more information on the Cobalt Link+ apps for iOS and Android please contact your VNC Automotive sales representative.

8.2 Additional hardware requirements

In addition to the Cobalt Cube, an iOS or Android device running the Cobalt Link+ app is required.

8.3 Connectivity and set-up instructions

8.3.1 Wi-Fi with Wi-Fi Hotspot (recommended)

Smartphone Control can control your device wirelessly via a local Wi-Fi Hotspot running on Cobalt Cube. The app helps in setting up and configuring the local Wi-Fi Hotspot network (with given name and password) that you can connect your mobile devices into.

Wi-Fi Hotspot on Cobalt Cube is the preferred option for wireless control of the smartphone. This gives the integrator the option to keep a vehicle's router available as a separate network. The hotspot configuration also allows a mobile device in the vehicle to connect to both a mobile data network and the local Wi-Fi hotspot provided by the Cobalt Cube.

Note: It is possible to set-up a Wi-Fi hotspot on a smartphone as the basis of the network used for connecting the Cobalt Cube and the phone, however this approach has not been officially tested at this time.

Open Cobalt Cube hidden settings:

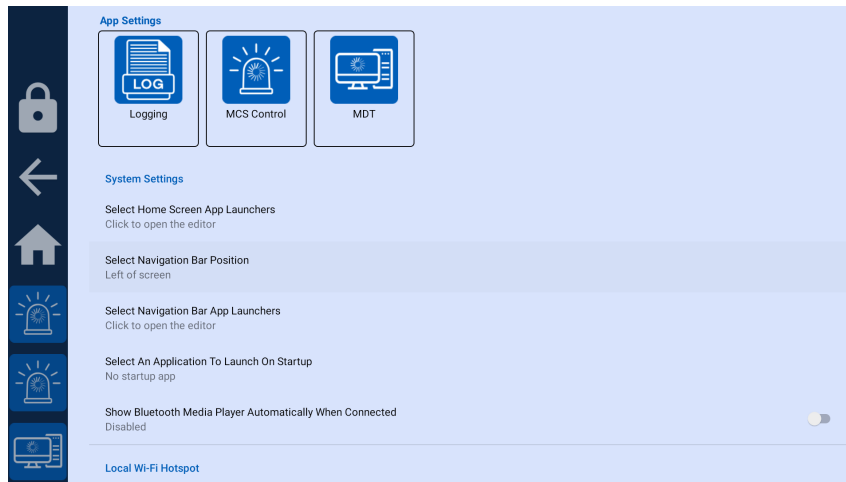

Figure 45: Cobalt Cube hidden settings

Head to the “Local Wi-Fi Hotspot” section and enable hotspot.



Figure 46: Local Wi-Fi Hotspot section

For regular users of the app once the vehicle is in service, the name and password of the created “Local Wi-Fi Hotspot” can be viewed, but not edited, in the My Settings app.

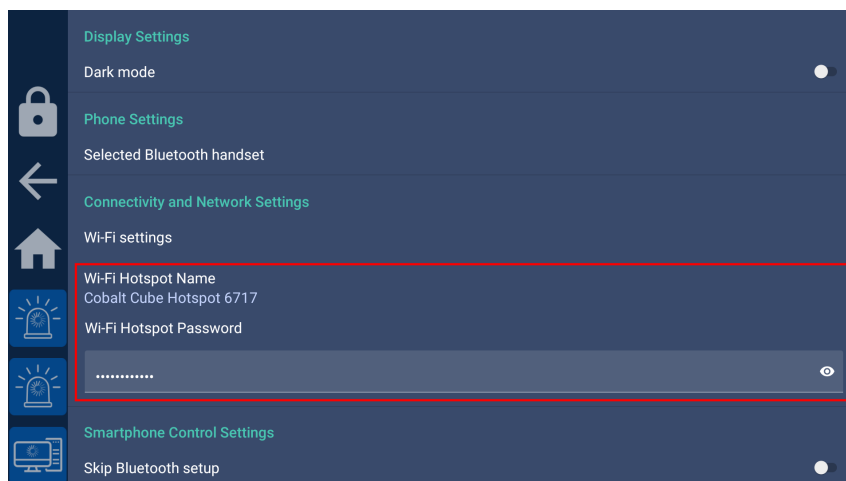

Figure 47: Local Wi-Fi Hotspot name and password

Once a “Local Wi-Fi Hotspot” is shown in the My Settings app, a mobile device can be connected to this hotspot, as shown in Figure 47.

For Android, it is important to connect to the hotspot using the Cobalt Link+ mobile app, rather than Settings. Enter the hotspot name and password into the Wi-Fi details dialog, which will appear when the broadcast button is pressed.

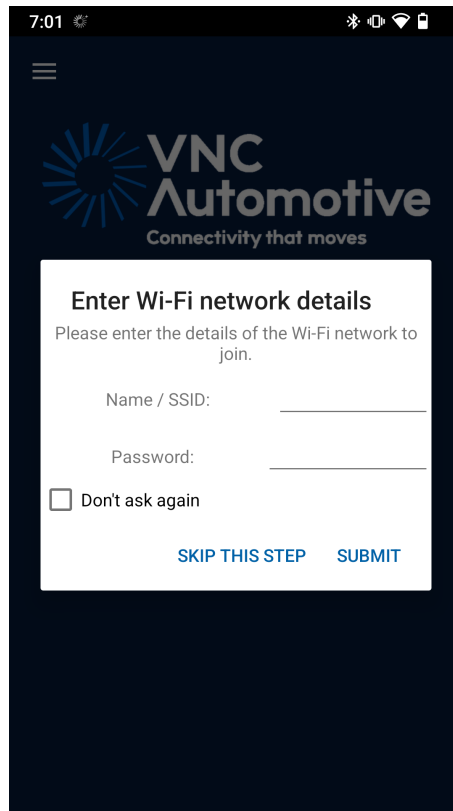

Figure 48: Cobalt Link+ app Wi-Fi details dialog

For iOS, connect to the hotspot using the Wi-Fi section in the Settings app. Select the hotspot by name from the list of networks.

8.3.2 Wi-Fi with Router

There must be a network to which both the mobile device and the Cobalt Cube are connected. The Cobalt Cube should be connected using an Ethernet cable (from its “ETHER-NET” port) to the router.

8.3.3 USB (Android only)

Smartphone Control also allows you to use your Android mobile devices with USB for connectivity. You can just plug your USB cable with your mobile device if you do not want to use Wi-Fi methods listed above.

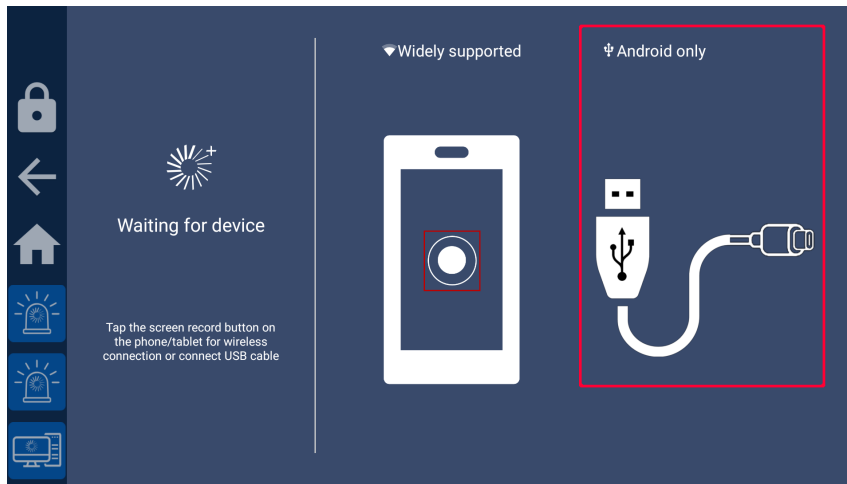

Figure 49: Cobalt Link+ USB connectivity

8.3.4 Working with the Smartphone Control app

After launching the app from the Cobalt Cube launcher by tapping the “Smartphone Control” icon, you will be presented with the following screen:

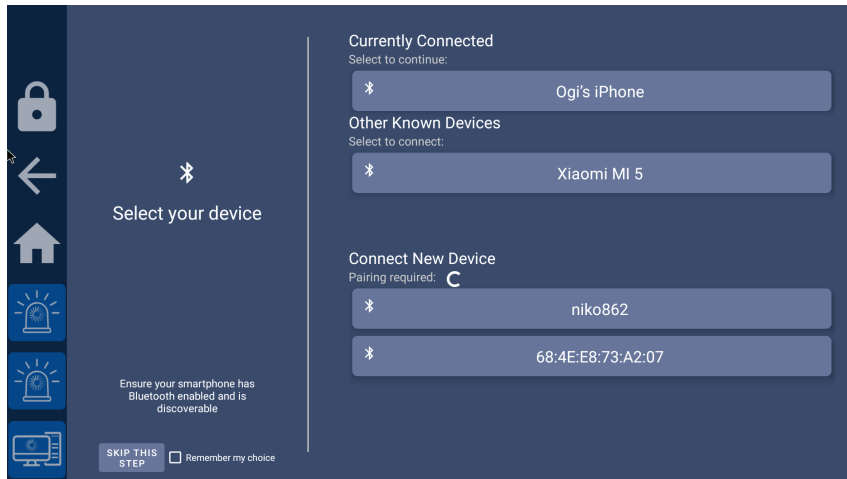

Figure 50: Smartphone Control Bluetooth device selection screen

This screen shows all available nearby Bluetooth mobile devices. Ensure your mobile device has Bluetooth enabled and is discoverable (most devices need to have the Bluetooth settings screen open). On this screen, you can choose your mobile device from the “Connect New Device” list to connect with. If there are lots of available devices nearby, you may need to scroll down the list in order to find your device. After connecting your mobile device, you can click your currently connected mobile device to continue.

This step is optional. If you do not want touch control, you can always skip this step by clicking the “Skip this step” button (if you want to skip this step permanently, you can also tick the “Remember my choice” checkbox next to the “Skip this step” button)

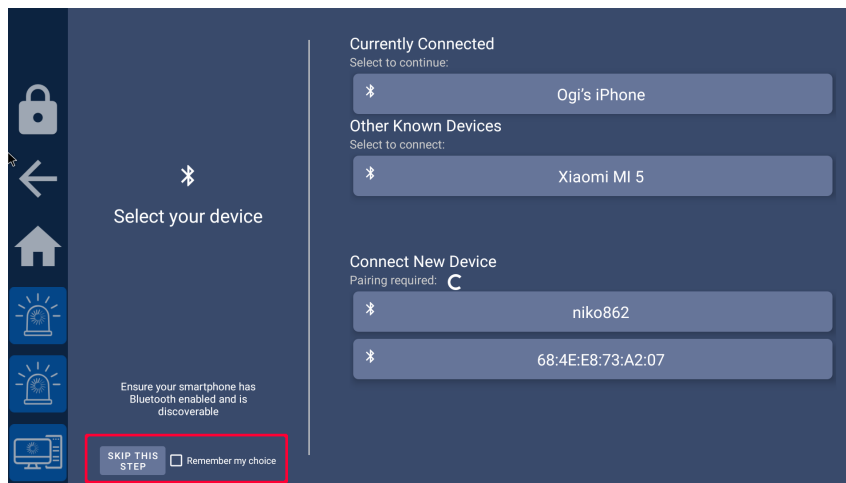

Figure 51: Skipping Bluetooth device selection screen

After you successfully set up Bluetooth connection with your mobile device, you will be presented with the following Cobalt Link+ device selection screen:

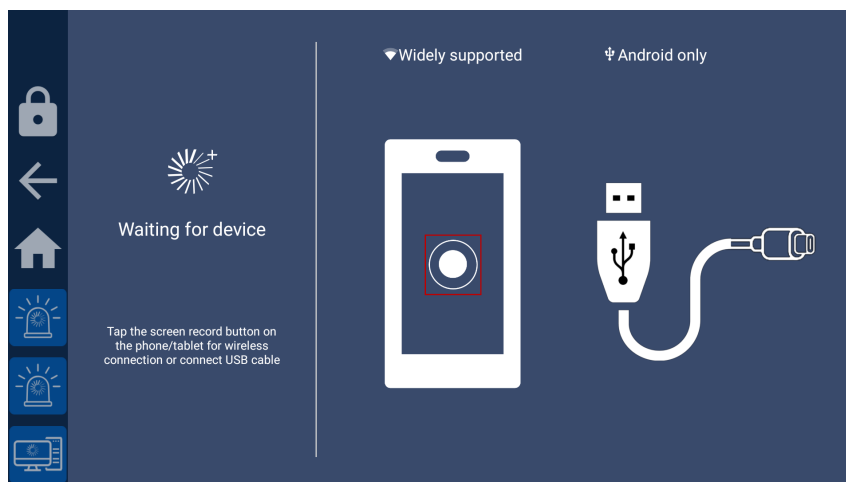

Figure 52: Smartphone Control Link+ device selection screen

At this stage, make sure one of the connection methods from the Cobalt Cube to the device is in place via one of the following methods (see section 8.3 for further details):

- a Wi-Fi router.
- a local Wi-Fi hotspot.
- a USB cable (Android only).

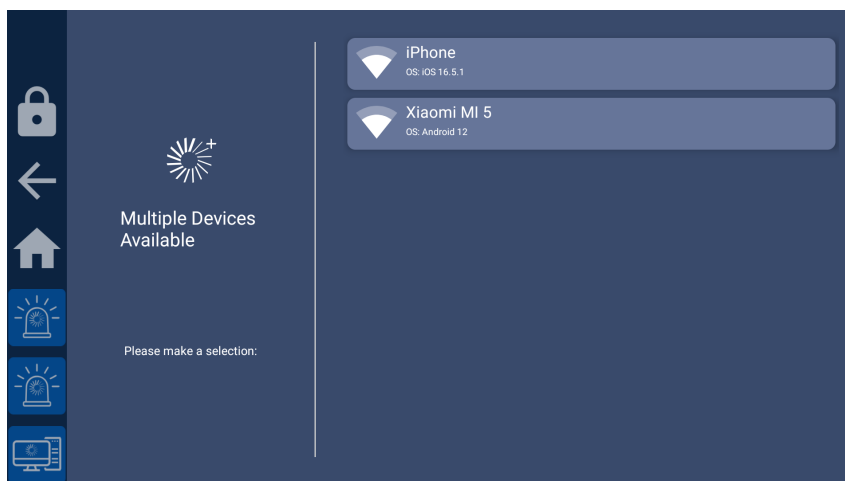

Figure 53: Multiple available Cobalt Link+ devices

This screen shows all Cobalt Link+ devices listening on the network. If you have started listening for connections on your mobile device and/or plugged your mobile device with USB cable to the Cobalt Cube, it will be listed on the screen as seen in Figure 53. For more information about this process, please refer to the documentation specific to your mobile platform, or the tutorial present in your Cobalt Link+ app.

After selecting your device, the connection will start, and the contents of the mobile device screen will be projected onto the Cobalt Cube. You may interact with and control your mobile device through this screen.

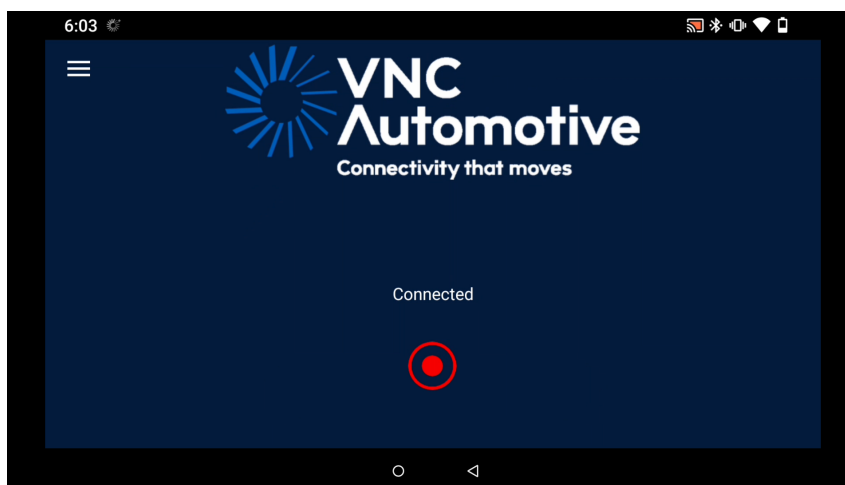

Figure 54: Projected device screen

The navigation bar is hidden during a projection session. To make it visible, swipe from the edge of the screen (where it usually is) towards the centre of the screen. It can then be used as normal to leave the session.

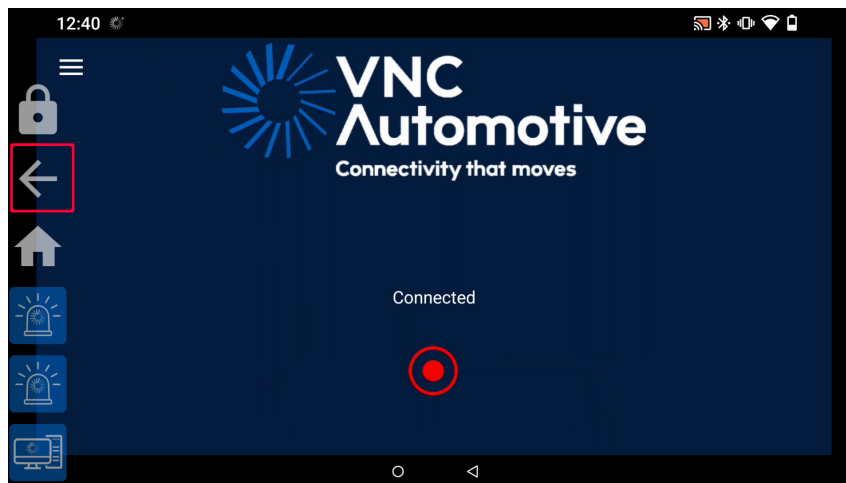

Figure 55: Exit from projection session

8.4 (OPTIONAL) Authentication

For enhanced security, authenticated connections can be enabled by specifying credentials in the activation code (see section 3.2.1). This will require those same credentials to be entered in the Cobalt Link+ mobile app on first use.

This is an optional feature - however, leveraging authentication enhances the overall security of sessions. For those seeking assistance or specific password options, contacting the VNC Automotive sales representatives is recommended.

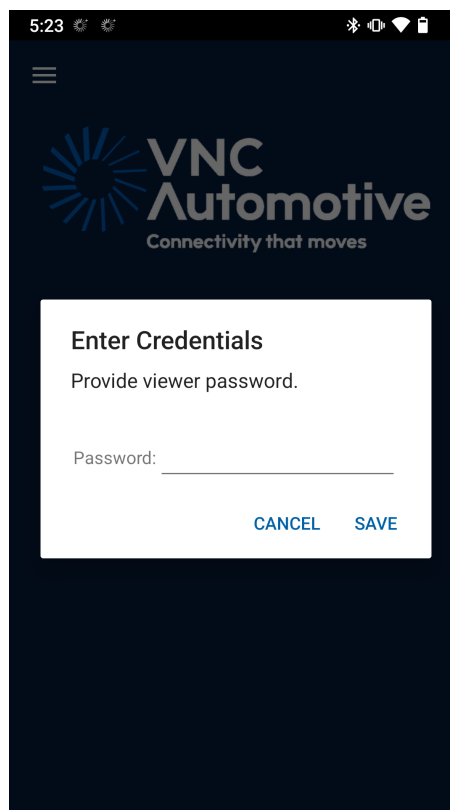

Figure 56: Cobalt Link+ app credentials entry

8.5 Auto-connection

After first setup and a successful projection session, Smartphone Control will automatically connect to your mobile device when you next open the app. On the subsequent

launch of the app, if you have at least one known device, you will be presented with the following screen:

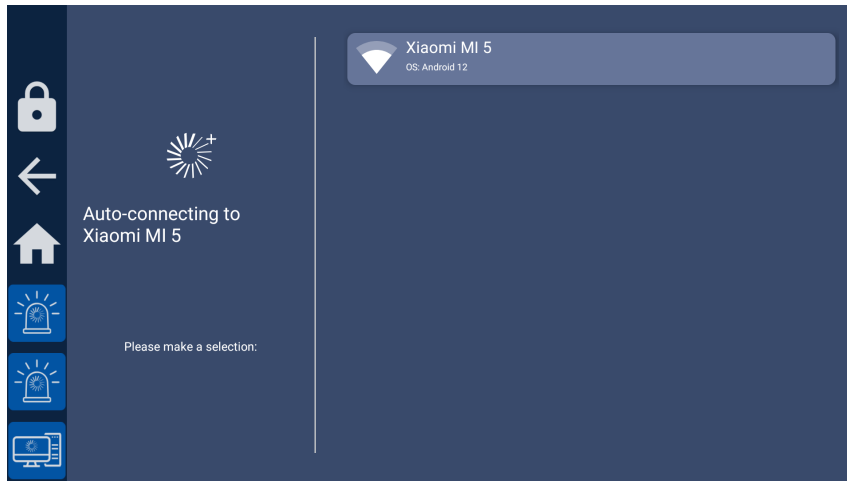

Figure 57: Smartphone Control Auto-connection feature

You do not need to do anything in this stage; Smartphone Control will automatically connect and start the session.

8.6 Smartphone Control settings

Smartphone Control settings can be found in the My Settings app. Launch My Settings by tapping the “My Settings” icon in the launcher. The settings options are shown in Figure 58.

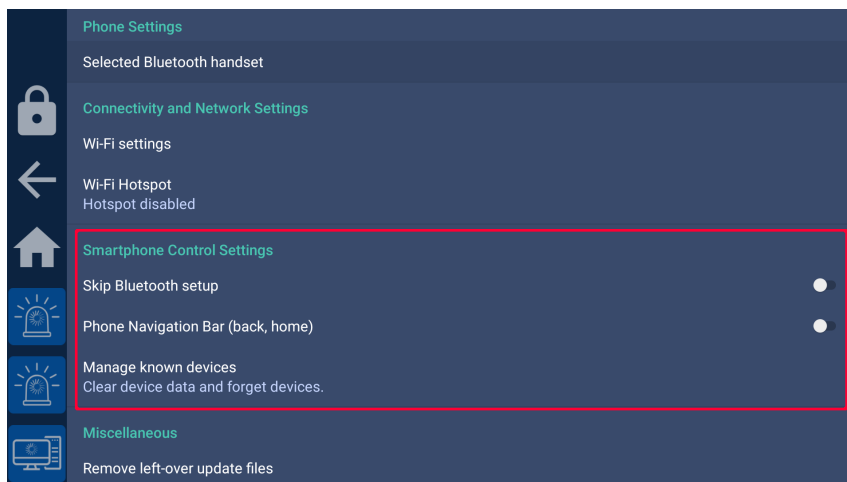

Figure 58: Smartphone Control app settings

8.6.1 Skip Bluetooth setup

This setting is used to skip the Bluetooth device selection page, either you do not want to see it on the subsequent run of the app (skip directly to the Cobalt Link+ device selection page), or you do not want touch control, you can use this setting. It is disabled by default so you will always be welcomed with the Bluetooth device selection page unless you enable this setting through here (My Settings) or through Smartphone Control itself (“Skip this step” option with the “Remember my choice” checkbox).

8.6.2 Phone Navigation Bar (back, home)

This setting is used to enable virtual device keys for the connected mobile device. It is disabled by default so you will not see any virtual device keys in projection unless you enable this setting.

8.6.3 Manage known devices

This setting is used to forget Cobalt Link+ devices and/or clear its data (iOS devices specific touch calibration data) which have previously been connected.

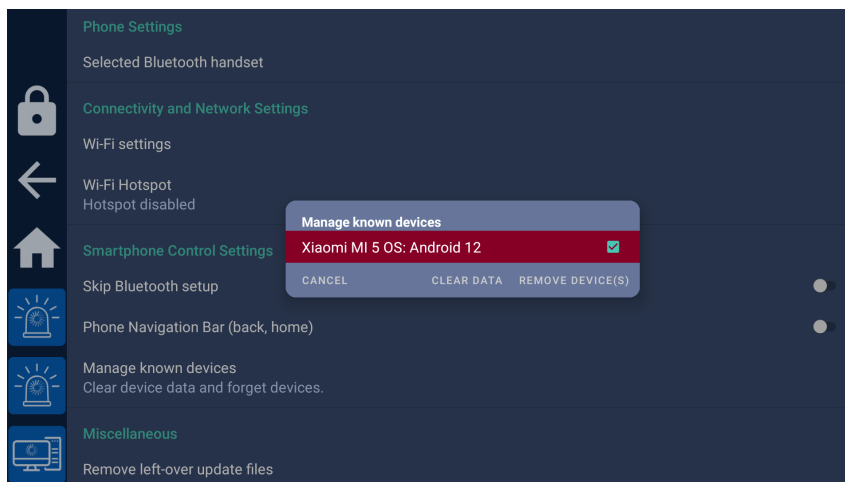

Figure 59: Manage known devices

Clear Data: This option is used for clearing app specific data for iOS devices

You can remove/forget your devices through here so auto-connection will not be performed for those removed devices.

(OPTIONAL) you can also unpair the Bluetooth device which was previously paired and connected with your Cobalt Link+ device by confirming as “yes” in the following dialog:

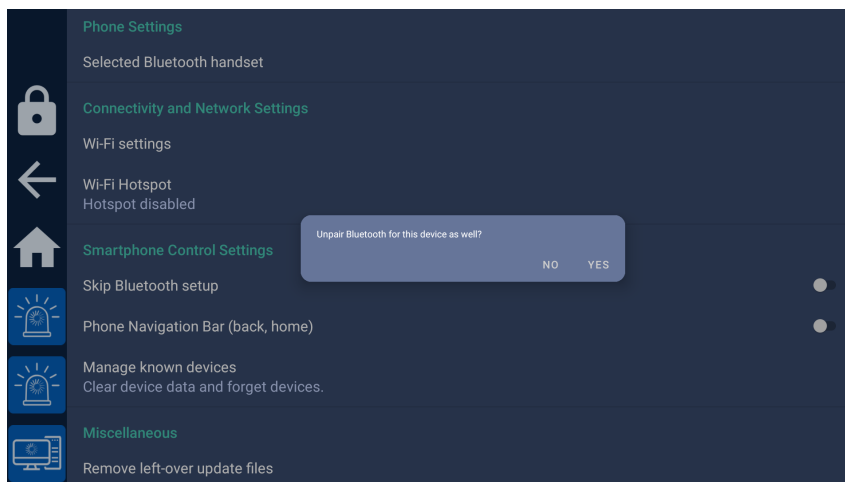

Figure 60: Unpair Bluetooth prompt

9 Use case: Genisys Control

9.1 Introduction

The Cobalt Cube Genisys Control application is designed to work with Ring Carnation’s Genisys hardware and firmware, which is pre-programmed for each set of vehicles.

The Genisys Control application works with the existing configuration of the Genisys Controller.

On application start, the software reads the handset configuration, via the USB-serial interface, and reflects the instantaneous state of each handset button, or combination of buttons, and shows this on the User Interface (UI).

9.2 Additional hardware requirements

Apart from the Cobalt Cube, the following hardware is required:

- Protocol Converter module from Ring Carnation. This must be flashed with the standard Ring Carnation firmware, and provide an available RS232 port, which will be connected to the Cobalt Cube. The address ID on the module must be set to 4.
- RJ11 to USB converter, which can be purchased from Ring Carnation. The converter consists of two connected cables: RJ11 to RS232 and RS232 to USB.
- Genisys Controller from Ring Carnation.

9.3 Connection instructions

The diagram below shows the connections between the Cobalt Cube, Genisys components, and IVI screen.

Connect the Genisys Controller to the Genisys Protocol Converter, via the included cable, following existing instructions from Ring Carnation. Connect the Cobalt Cube to the Genisys Protocol Converter module, via the RJ11 to USB converter cable. Use the RS232 port on the Genisys Protocol Converter module and the USB Host port on the Cobalt Cube.

If required, connect the handset to the Genisys Protocol Converter, via the RJ11 cable provided.

Connect the Cobalt Cube to the In Vehicle Infotainment (IVI) screen, via the USB OTG port on the Cobalt Cube. A USB-A to USB-C cable of the appropriate length is required for this connection.

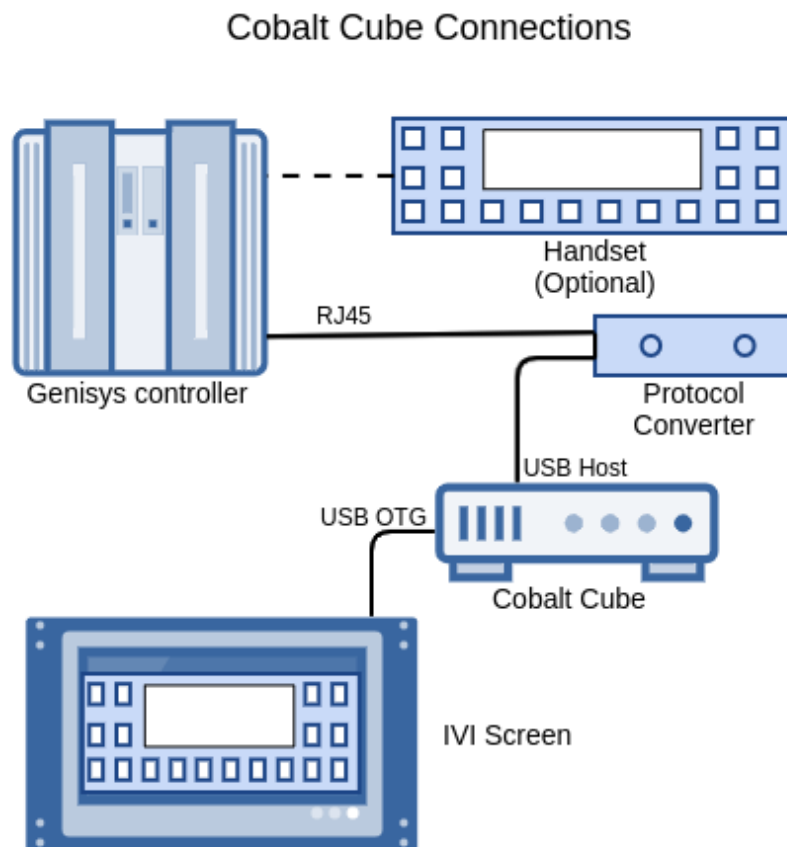

Figure 61: Cobalt Cube connections

9.4 Operating instructions

The Genisys Control application can be run by tapping the “Genisys Control” application icon from the Cobalt Cube app launcher screen, which appears on the IVI screen.

The UI for the handset is individually tailored for each customer and follows the same layout as the hardware handset. Each button can be pressed on the vehicle’s IVI screen to operate the Genisys Controller in the same way that is done on the hardware handset. This operation happens with or without the hardware handset present in the vehicle.

When the navigation bar is disabled, tapping the back arrow at the top left takes the user back to the Cobalt Cube app launcher screen.

The screenshots in Figure 62 and Figure 63 show representations of the UI with buttons on and off.



Figure 62: Genisys Control buttons off

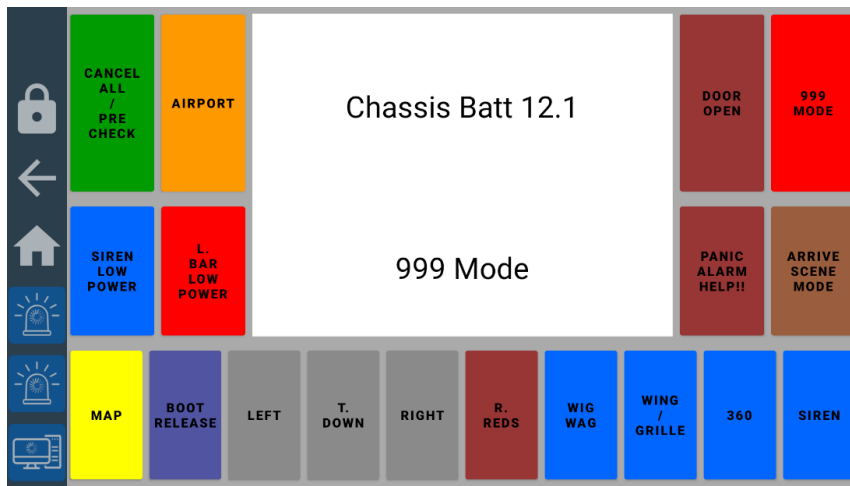

Figure 63: Genisys Control with some buttons on

If the Genisys system is not connected to the Cobalt Cube via the USB-serial cable, the error in Figure 64 will be shown.

In this case, check the USB Host port has the USB cable plugged in and tap retry. Tapping "QUIT" exits to the Cobalt Cube app launcher screen.

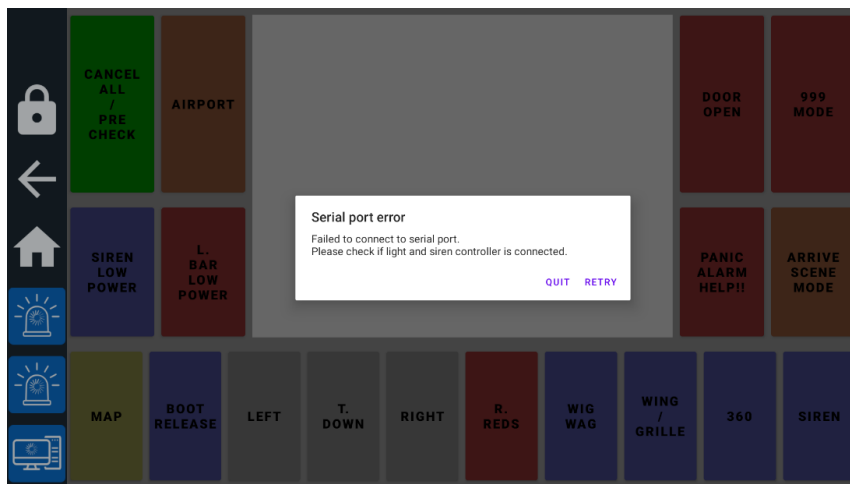

Figure 64: Serial port error

10 System utilities

10.1 Extracting system logs

From time to time, inconsistencies or other undesired behaviour with Cobalt Cube may be noticed by users during normal operation. The device now comes with built in system log capture. This is a tool intended to be used by technical support agents via suppliers or vehicle fitters so that detailed information about the state of the system at the present time, or over a historical period, can be extracted and sent away for analysis.

The built-in logger is a support feature and is not intended for vehicle users during day-to-day functioning of the Cobalt Cube. This section covers the Logging app, which allows the Cobalt Cube to save logs that can be sent to VNC Automotive in the event of an issue.

10.1.1 UI overview



Figure 65: Logging app settings

1. Logging Toggle
 - i. This toggles the logging feature on or off. When this is off, no logs can be written manually or automatically.
 - ii. When this is on, the other logging features are available.
2. Start on Boot Toggle
 - i. When this is enabled, Logging will start on boot using the same configuration as before the Cobalt Cube was rebooted.
 - ii. When this is disabled, Logging will not start up automatically on boot.
3. Selected storage device
 - i. The storage device highlighted in green is where the log files will be written to. The size next to the device is the maximum space the log files can take up on the device.
 - ii. Internal Storage corresponds to `/vnc/logging/`.
 - iii. Devices are selected or unselected by tapping on them.
4. Other storage device
 - i. The greyed-out storage devices are unselected and will not have any logs written to them.
5. Size of logs to keep

- i. This is the maximum size all the log files on a device will cumulatively take up. E.g., if this is set to 1GB then up to 1GB of log files will be written, before the oldest log files will start being overwritten to ensure the total size does not exceed 1GB.
 - ii. The minimum size is 19MB.
6. Size of logs slider
 - i. Moving this left decreases the size of logs to keep and moving it to the right increases the size of logs to keep.
7. Auto-write logs
 - i. When enabled, logs will be written to the storage device every few minutes automatically without user interaction.
 - ii. When disabled, logs are recorded only when user initiated, or when the Cobalt Cube disconnects from the car head unit.
8. Dump latest buffer
 - i. This immediately writes a log file to the selected storage device.
 - ii. When pressed a toast will appear indicating whether the writing was successful or unsuccessful.

10.1.2 Additional information

- It can take 1-2 minutes for Logging to start up after boot.
- Do not turn off the Cobalt Cube or remove the selected storage device after manually dumping logs until the result has been indicated.
- If a valid storage device is not selected, the Logging service will be unable to save logs.
- The storage devices must be formatted to FAT32 and have a minimum size of 19MB.
- On USB storage devices the log files are written to `/Android/data/com.vncautomotive.logging/files/`.

10.1.3 Enabling logging

- 1) Enable the Logging service:

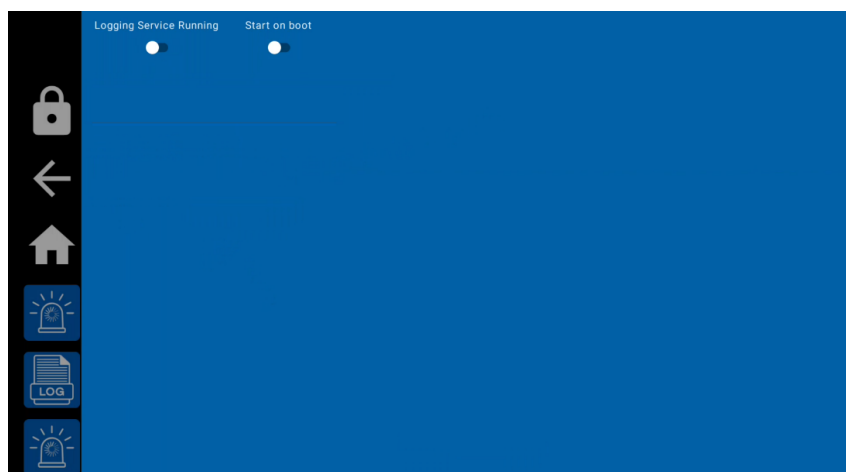

- 2) Select your preferred storage device:

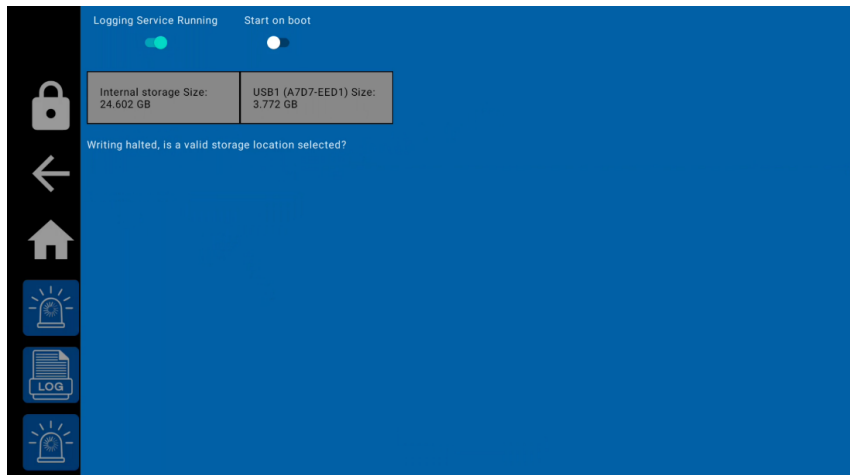

3) Adjust maximum size of total logs:

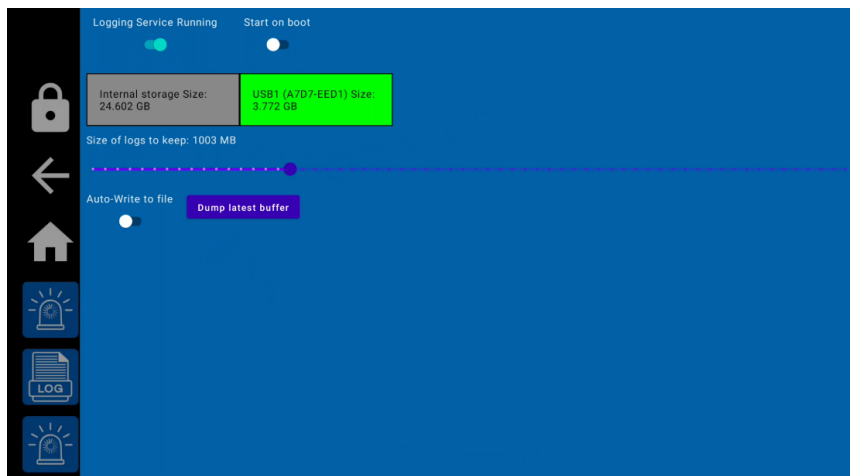

4) Enable auto-writing logs:

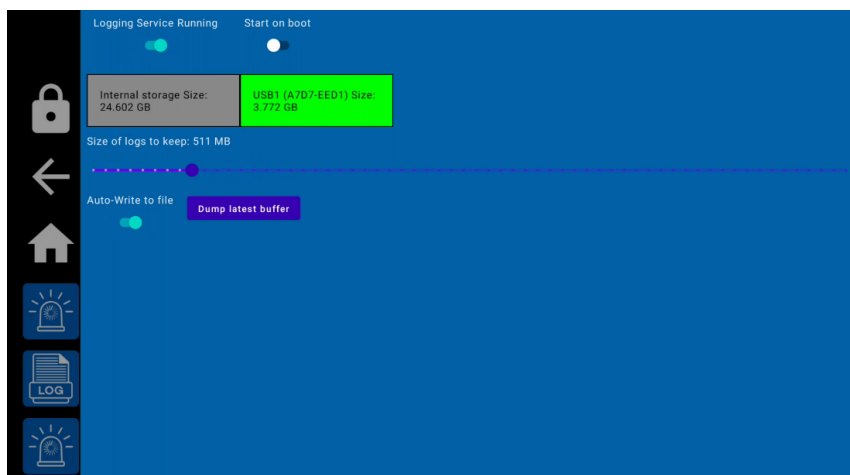

10.1.4 Enable user-facing log button

The Logging app can be added to the home screen or navigation bar (see section 4.6 for details). When the app is on either the home screen or navigation bar, it functions like the “Dump latest buffer” button. So any user can initiate the writing of log files by clicking the app icon. Logging must be enabled and set up for this to work.

10.1.5 Extracting log files from the Cobalt Cube

When you are ready to retrieve the log files from the Cobalt Cube, they will need to be moved to a computer so they can be transferred to VNC Automotive. If they were saved directly to a USB device, then it can be removed and plugged into a computer for transfer. If the logs were saved to the internal storage device, the following steps can be used copy the logs to an attached USB.

1. Logs stored in the internal storage of the Cobalt Cube can be found at `/vnc/logging/`. This directory can be accessed by opening the files app and clicking “Show Internal Storage”:

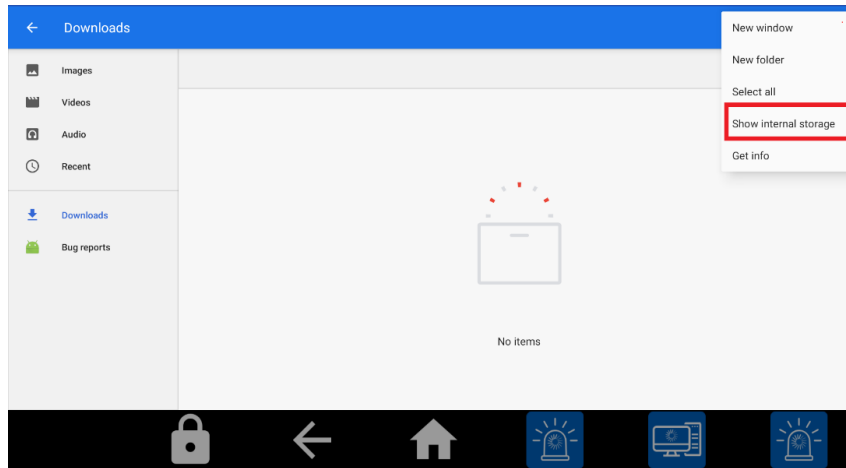

2. Select the Cobalt Cube storage device on the left-hand menu:

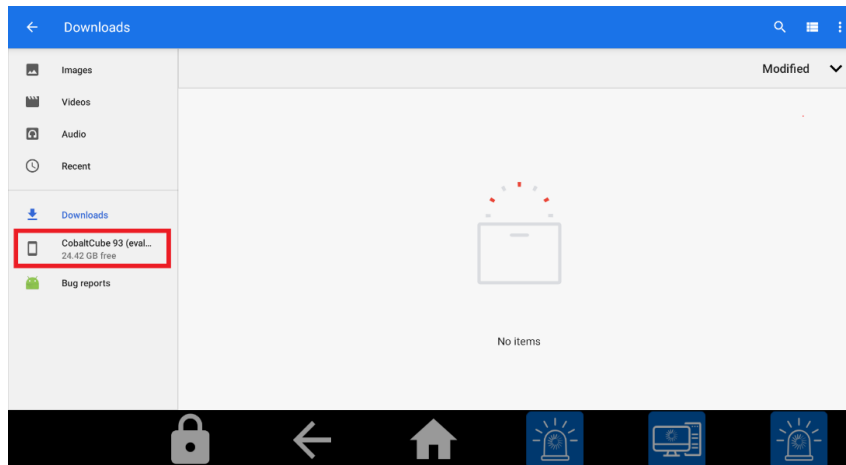

3. Navigate to `/vnc/logging/`:

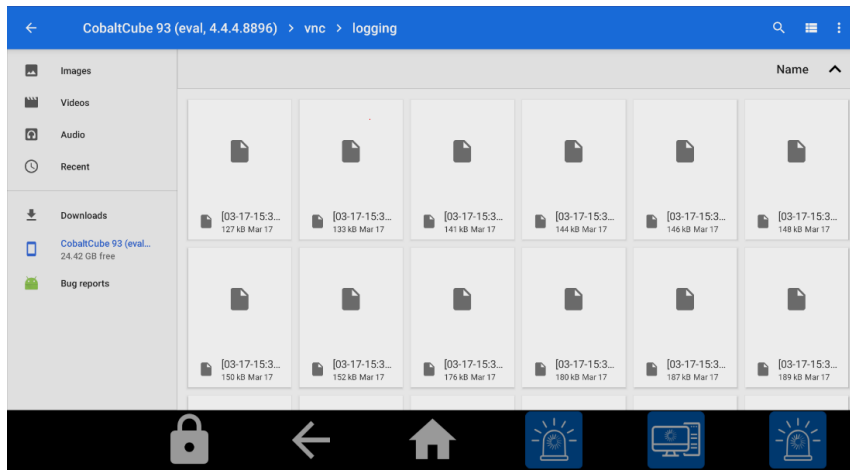

4. Long press to select the log(s) and select copy to in the menu at the top right:

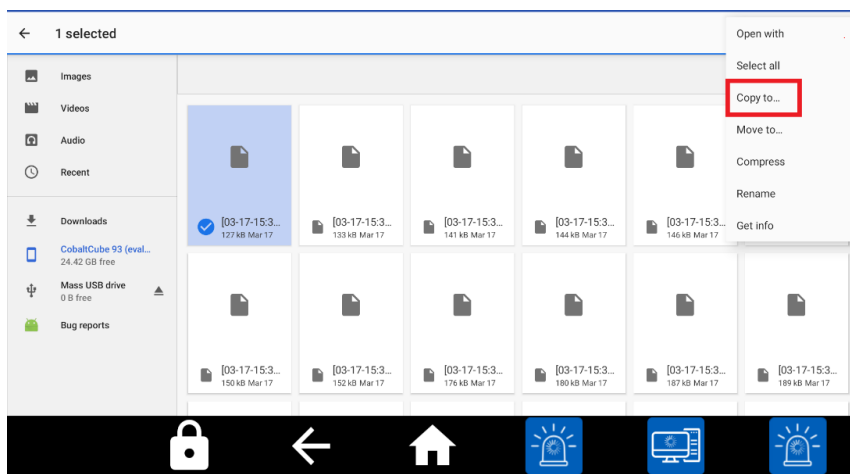

5. Navigate to the USB flash drive and click copy:

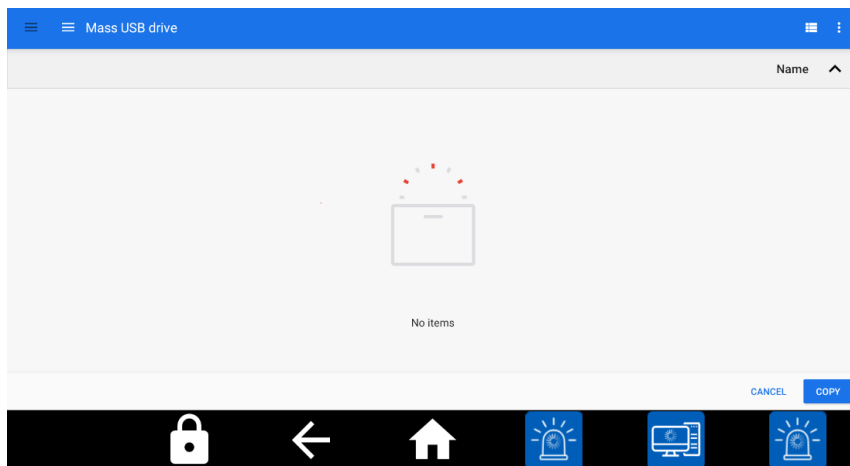

6. Once the files have been copied, they will show in the USB flash drive:

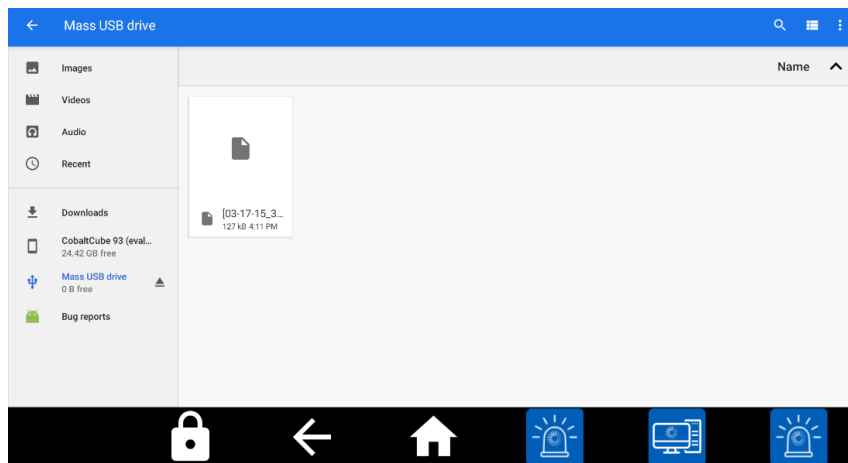

7. The USB flash drive can then be ejected, and the log files can be sent to VNC Automotive for examination.

11 Troubleshooting

11.1 Troubleshooting the Android Auto connection

If after following the steps in section 3.1, the Cobalt Cube is still not showing on the head unit, please do the following:

- Check if any action on the head unit is required to start the Android Auto connection. Some vehicles may show a notification that needs to be clicked on or require navigating to a particular menu to start the connection.
- Unplug and re-plug the USB cable from the Cobalt Cube. Please allow up to 2 minutes after re-plugging the Cobalt Cube for the connection to succeed. It is worth trying this a couple of times.
- If the above steps fail, the Android Auto prompts will need to be accepted manually as described in section 11.2.

11.2 Manual acceptance of Android Auto prompts

In the case that the automated process fails after following the troubleshooting steps in section 11.1, you will need an HDMI screen to accept the terms and conditions for using Android Auto. Once complete, subsequent connections to the same car occur without any additional input.

The steps to perform this initial setup are as follows:

1. Connect the Cobalt Cube to the vehicle IVI system via the OTG port (you may need a USB-C to USB-A adapter).
2. Connect an HDMI monitor to the Cobalt Cube's HDMI port.
3. Connect a mouse or touchscreen USB connector to the Cobalt Cube's HOST port.
4. Start Android Auto on the IVI system.
5. You should see a series of dialogues appear on the HDMI screen (as seen in Figure 66) - accept all of them.

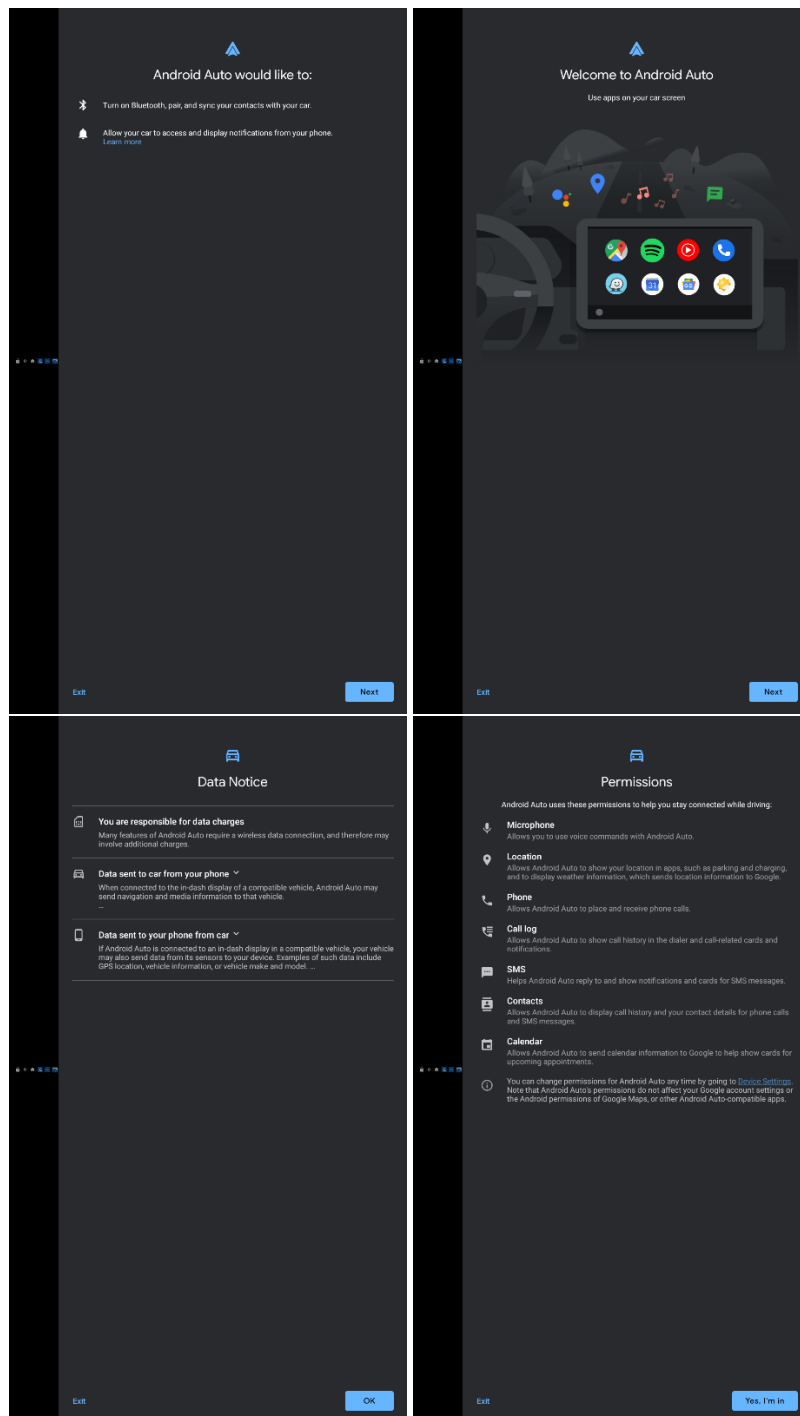

Figure 66: Some of the Android Auto first experience screens

12 Frequently asked questions

12.1 Is it possible to navigate around the Cobalt Cube without establishing a connection to a vehicle head unit?

Yes. A USB mouse can be connected to the HOST port of the Cobalt Cube. Alongside an HDMI screen, this allows navigation around the Cobalt Cube. To go back to the previous screen the navigation bar can be used, or the “back” button in the mouse, if available.

12.2 Is it possible to factory-reset the Cobalt Cube?

Yes. The option can be found in:

Settings > System > Advanced > Reset Options > Erase all data (factory reset)
> Reset Tablet

It is important that you reboot the Cobalt Cube at least once after a factory reset, so all applications get a chance to set up their configuration files appropriately.

12.3 How long can the USB cable be for a reliable Android Auto connection?

This will depend a lot on the quality of the cable used, but we advise you to use the shortest possible cable and ideally install the Cobalt Cube near to the car's Android Auto USB port. Google's official advice on USB cables is available through their knowledge base here: <https://support.google.com/androidauto/answer/6348190?hl=en-GB#zippy=%2Ccheckyour-usb-cable>.

For quick reference it is recommended that you use a cable that is:

- Less than 3 feet (1 meter) long and don't use USB hubs or cable extensions.
- USB-IF certified within the last two years. Here is a database you can check: <https://www.usb.org/products>.

12.4 The "Firmware Updating" pop-up shows on every boot after an update

This is due to an update file remaining on the SD Card after an update. The file can be removed by going into the My Settings app and clicking "Remove left-over update files". After this, the pop-up will no longer appear.

12.5 Can two devices be connected to the Cobalt Cube for media audio simultaneously?

No, they cannot. To use a device as an audio source, it must be enabled for media audio in the Cobalt Cube's Android settings. Only one device can be enabled at a time.

Note: phone call audio in addition to media audio is supported (from either the same, or different, source devices). To set-up phone call support, please refer to section 4.9.

12.6 The phone's display is very compressed in Smartphone Control.

This can be the result of using a head unit with a low resolution and a phone with a high resolution. Generally, the higher resolution the head unit is, the better phone screens will look on them. Putting the phone in portrait mode for a portrait head unit or landscape mode for a landscape head unit will also help maximise the usable space and picture quality.

12.7 The Smartphone Control hotspot remains pending indefinitely after being turned on.

For the Local Wi-Fi hotspot to turn on, Smartphone Control needs to be opened. If this still does not turn on the hotspot, please ensure that the Local Wi-Fi hotspot password is at least 8 characters long. Using a password of less than 8 characters will result in the hotspot not turning on.

12.8 The display of the Cobalt Cube turned off during an update and now it won't power back on. What can I do?

This may occur if power was lost during an update of the device, or if the USB thumb drive became loose whilst data was being copied. You will need to return the unit to be restored by a technician.

Let's discuss your project

As industry pioneers, we will help you cut through the complexity and deliver ingenious connectivity technology for the vehicles of tomorrow.

Get in contact via:

www.vncautomotive.com

technicalsupport@vncautomotive.com

No part of this documentation may be reproduced in any form or by any means or be used to make any derivative work (including translation, transformation or adaptation) without explicit written consent of VNC Automotive.

All information contained in this document is provided in commercial confidence for the sole purpose of use by an authorized user in conjunction with VNC Automotive products. The pages of this document shall not be copied, published, or disclosed wholly or in part to any party without VNC Automotive prior permission in writing, and shall be held in safe custody. These obligations shall not apply to information which is published or becomes known legitimately from some source other than VNC Automotive.

