

# Getting Started Guide

Cobalt Cube<sup>®</sup>



## Contents

<b>1</b>	<b>Introduction</b>	<b>3</b>
<b>2</b>	<b>Cobalt Cube overview</b>	<b>3</b>
2.1	Cobalt Cube ports	3
2.2	Cobalt Cube basic hardware setup	4
2.3	Cobalt Cube power connector	4
<b>3</b>	<b>First-time setup</b>	<b>5</b>
3.1	Automated acceptance of Android Auto prompts	5
3.2	Product activation	5
3.2.1	Activation codes	6
3.2.2	Activating a Cobalt Cube	6
<b>4</b>	<b>System customisation</b>	<b>7</b>
4.1	Accessing Cobalt Cube settings	7
4.2	Settings PIN lock	8
4.3	Application specific settings	9
4.4	Changing the display name for an application	9
4.5	Navigation bar	10
4.5.1	Position	11
4.5.2	Navigation bar quick launch apps	12
4.6	Setting up the home screen	13
4.7	Setting a startup application	13
4.8	Setting a custom Network Time Protocol (NTP) server	14
4.9	Phone call support	15
4.9.1	Setup	15
4.10	Bluetooth Audio	17
4.10.1	Setup	17
4.10.2	Bluetooth Media Player	17
4.10.3	Bluetooth Automatic Reconnect	19
<b>5</b>	<b>Updating the system image</b>	<b>19</b>
5.1	Rebooting the Cobalt Cube	20
5.2	Activating new features	21
<b>6</b>	<b>Use case: MCS Control</b>	<b>22</b>
6.1	Introduction	22
6.2	Additional hardware requirements	23
6.3	Connectivity instructions	23
6.4	Working with the MCS Control app	24
6.5	Configuring the MCS Control application	26
<b>7</b>	<b>Use case: MDT (Mobile Data Terminal) Control</b>	<b>27</b>
7.1	Introduction	27
7.2	Additional hardware requirements	27
7.3	Connectivity instructions (Router)	28
7.4	Connectivity instructions (Direct)	28
7.5	Assign static IP address for Ethernet adapter Cobalt Cube	28
7.6	Assign static IP address for Ethernet adapter Windows PC	28
7.7	Working with the MDT application	29
7.8	MDT configuration	30
<b>8</b>	<b>Use case: Smartphone Control</b>	<b>34</b>
8.1	Introduction	34
8.2	Additional hardware requirements	34
8.3	Connectivity and set-up instructions	34
8.3.1	Wi-Fi with Wi-Fi hotspot	34
8.3.2	Wi-Fi with Router	36
8.3.3	USB (Android only)	36
8.3.4	Working with the Smartphone Control app	36

8.4	Auto-connection . . . . .	39
8.5	Authentication (optional) . . . . .	39
8.6	Smartphone Control settings . . . . .	40
8.6.1	Phone Navigation Bar (back, home) . . . . .	40
8.6.2	Manage known devices . . . . .	41
8.6.3	Remote Control via Bluetooth . . . . .	42
8.6.4	Screen orientation lock . . . . .	42
<b>9</b>	<b>Use case: Genisys Control</b> . . . . .	<b>42</b>
9.1	Introduction . . . . .	42
9.2	Additional hardware requirements . . . . .	42
9.3	Connection instructions . . . . .	42
9.4	Operating instructions . . . . .	43
<b>10</b>	<b>System utilities</b> . . . . .	<b>45</b>
10.1	Extracting system logs . . . . .	45
10.1.1	UI overview . . . . .	45
10.1.2	Additional information . . . . .	46
10.1.3	Enabling logging . . . . .	46
10.1.4	Enable user-facing log button . . . . .	47
10.1.5	Extracting log files from the Cobalt Cube . . . . .	48

# 1 Introduction

The instructions detailed in this document will allow you to set up and evaluate the Cobalt Cube® hardware, as long as it has been flashed with a VNC Automotive production system image.

This document covers the following use cases:

- MCS Control: provision of control of lights, sirens, etc. via the MCS Control app, which communicates with Standby® MCS hardware. The app emulates a particular MCS handset to provide this control and display of buttons.
- MDT Control: display of and interaction with a Microsoft® Windows® PC. This may be running, for example, Automatic Number Plate Recognition (ANPR) software connected to the Cobalt Cube's network. This use case also extends to mirroring other applications that may be present on the PC.
- Smartphone Control: display of and interaction with applications running on a connected device (either Android or iOS).
- Genisys Control: provision of control of lights, sirens, etc. via the Genisys Control app, which communicates with Ring Carnation® hardware. The app emulates a particular Ring Carnation® handset to provide this control and display of buttons and text notifications.

## 2 Cobalt Cube overview

### 2.1 Cobalt Cube ports

The Cobalt Cube has a series of labelled ports. This guide will refer to some of them, this section details their purpose.



Figure 1: Cobalt Cube

- HDMI: HDMI out port, to connect the Cobalt Cube directly to a screen over HDMI. This can be used for troubleshooting the Android Auto connection (see the Cobalt Cube FAQs page).
- POWER: 12V power input.
- GPS: port to connect a GPS antenna to improve GPS positioning. It is not required for any use case covered in this document.
- ETHERNET: port to connect an RJ45 cable, to allow an Ethernet connection to the network.

- OTG: USB-C port. Provides 5V power input to the device. USB OTG connectivity to 3rd party devices is supported.
- HOST: USB Standard-A port. Can be used to connect USB thumb drives or USB peripherals (e.g., a mouse) to the Cobalt Cube.
- DCP: USB Standard-A port for DC output (5V).

## 2.2 Cobalt Cube basic hardware setup

1. For use cases which require network connectivity: connect one end of the Ethernet cable to the ETHERNET port on the Cobalt Cube, and the other end to a free port on the network router/switch.
2. Connect a USB-A to USB-C cable to the Cobalt Cube. The USB-A end should plug into the Android Auto port on the vehicle and the USB-C end should be connected to the Cobalt Cube.
3. Plug the 12V power block into the POWER port of the Cobalt Cube.

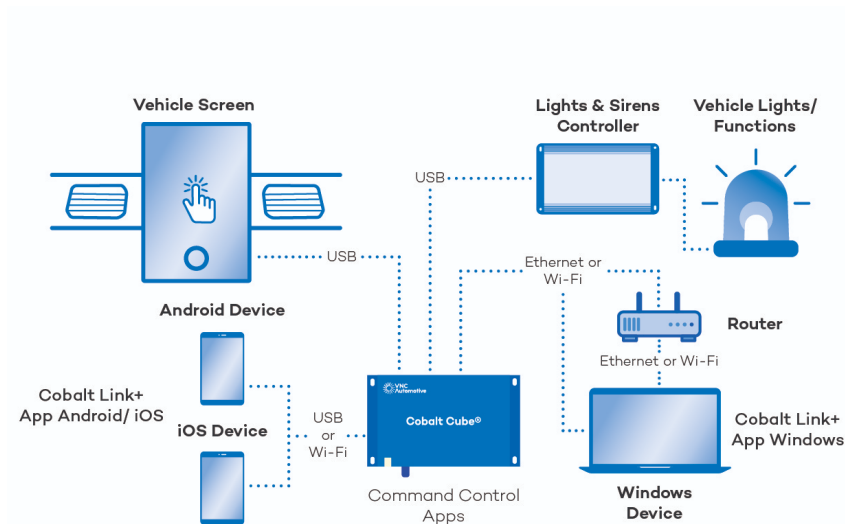

Figure 2: Possible hardware layout

## 2.3 Cobalt Cube power connector

Item	Part Number	Supplier Link
<b>Power Connector</b>	172167-1	<a href="https://uk.farnell.com/amp-te-connectivity/172167-1/plug-housing-4way/dp/1248283">https://uk.farnell.com/amp-te-connectivity/172167-1/plug-housing-4way/dp/1248283</a>
<b>Metal Contacts (x3)</b>	170362-1	<a href="https://uk.farnell.com/amp-te-connectivity/170362-1/contact-socket-22-18-awg-crimp/dp/1772741">https://uk.farnell.com/amp-te-connectivity/170362-1/contact-socket-22-18-awg-crimp/dp/1772741</a>

The image below shows the side view of the power connector included with the Cobalt Cube.

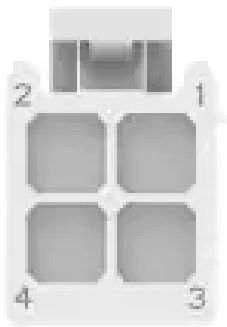

Figure 3: Cobalt Cube power connector

The connector can be cabled into the vehicle as follows:

Pin number	Function
1	Ground
2	-
3	Battery plus
4	Accessory

For the Cobalt Cube to operate correctly, it must receive a constant 12v supply to both the battery plus and accessory pins. Therefore, it is advised to connect both cables to the same battery.

If the vehicle has an auxiliary battery to keep devices powered when the engine/main battery is off, the Cobalt Cube should have both battery plus and accessory connected to this auxiliary supply.

## 3 First-time setup

### 3.1 Automated acceptance of Android Auto prompts

The first time the Cobalt Cube is connected to a particular vehicle there are set-up prompts from Android Auto that need to be accepted. This process has been automated so that no user interaction is required. The Cobalt Cube needs to be powered on and plugged into the vehicle, then after 1-2 minutes, the Cobalt Cube screen should appear on the head unit. If the Cobalt Cube does not show on the head unit, follow the steps in the Cobalt Cube FAQs page.

### 3.2 Product activation

The Cobalt Cube must be activated before it can be used. This is part of a wider, new addition to the product in version 2.0, namely Enterprise Device Management for your fleet of Cobalt Cube units. The feature supports dynamic configuration and deployment of apps, services and settings. This is particularly useful for batches of units installed and/or managed by the same supplier, which are in use by different groups of users with differing needs. Product activation involves a unique code(s), including all the dynamic configuration required for the deployed unit(s).

Product activation can be carried out before or after the unit has been fitted in a vehicle. When activating outside of a vehicle, attach an HDMI monitor and a mouse. In a vehicle, the vehicle's head unit can be used when activating the Cobalt Cube. Until a Cobalt Cube is activated, it will remain on the screen shown in Figure 4.

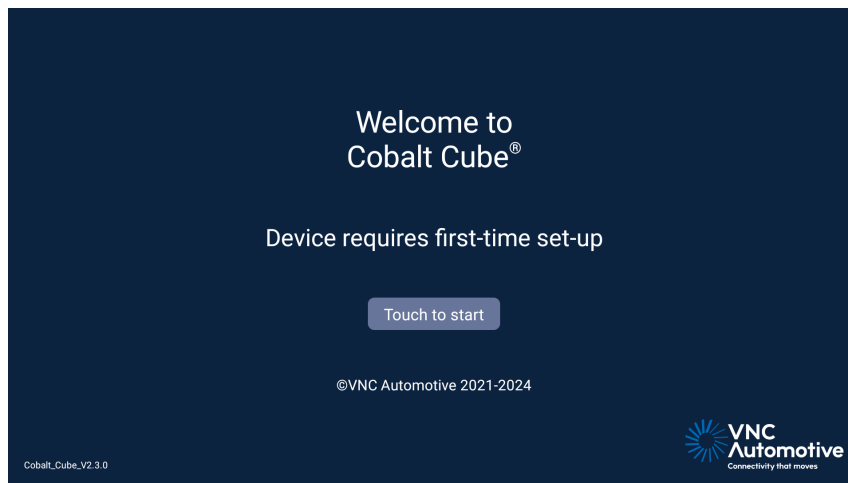

Figure 4: Welcome screen for Cobalt Cube activation

### 3.2.1 Activation codes

If you do not have an activation code for your Cobalt Cubes, contact your VNC Automotive representative to discuss your needs.

### 3.2.2 Activating a Cobalt Cube

On the screen in Figure 4, click “Touch to start”. The screen in Figure 5 will appear. Put your activation code on the USB storage device. It is important that this file is not renamed between receiving it from VNC Automotive and applying it to a Cobalt Cube.

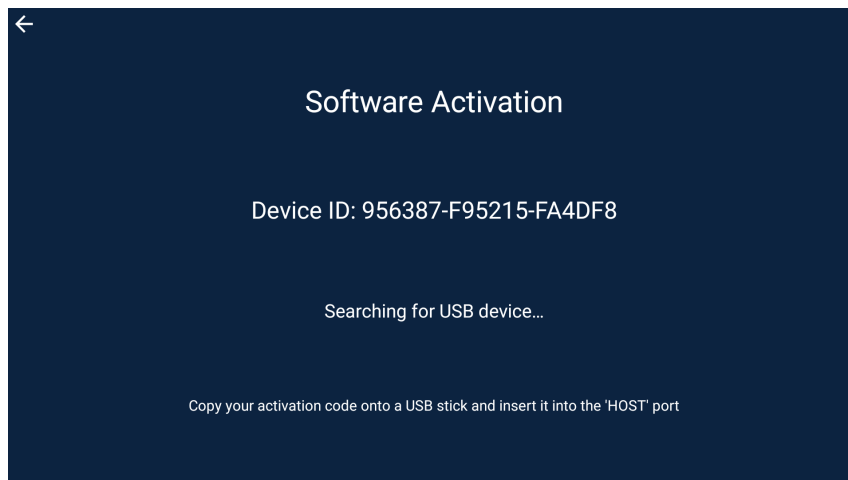

Figure 5: Activation screen

Insert the storage device with the activation code into the Cobalt Cube’s “HOST” port. When activating the Cobalt Cube in a vehicle, it may be easier to do this before starting the engine, if the Cobalt Cube is stored out of reach from the driver’s seat. When the storage device is detected by the Cobalt Cube, it will read the activation code and start the activation process, which should only take a few seconds. This will enable all purchased apps and apply any settings that have been specified in the activation code. Upon a successful activation, the screen in Figure 6 will appear. Touch anywhere to navigate to the launcher screen shown in Figure 7.

**Note:** if the storage device is not detected after ten seconds, try removing it and re-inserting it.

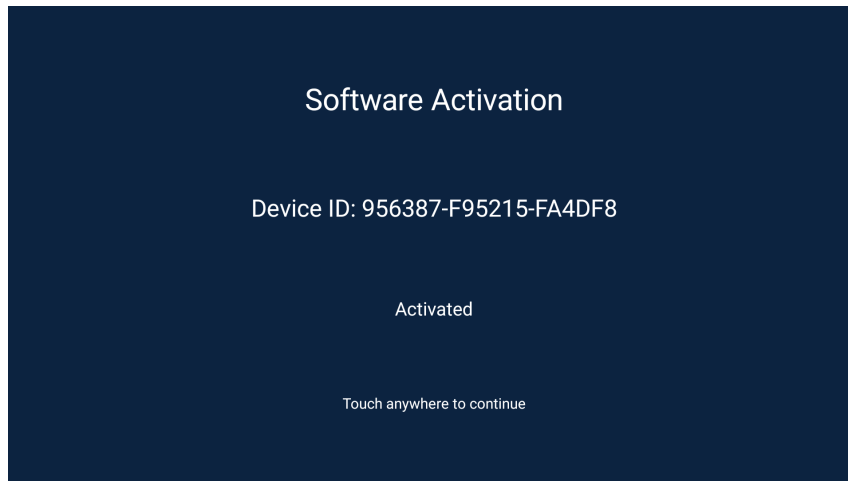

Figure 6: Activated screen

## 4 System customisation

The Cobalt Cube comes pre-installed with Android and includes a selection of applications based on the options purchased. The Android image can be updated (see section 5). All installed applications can be launched from the Cobalt Cube launcher, shown in Figure 7.

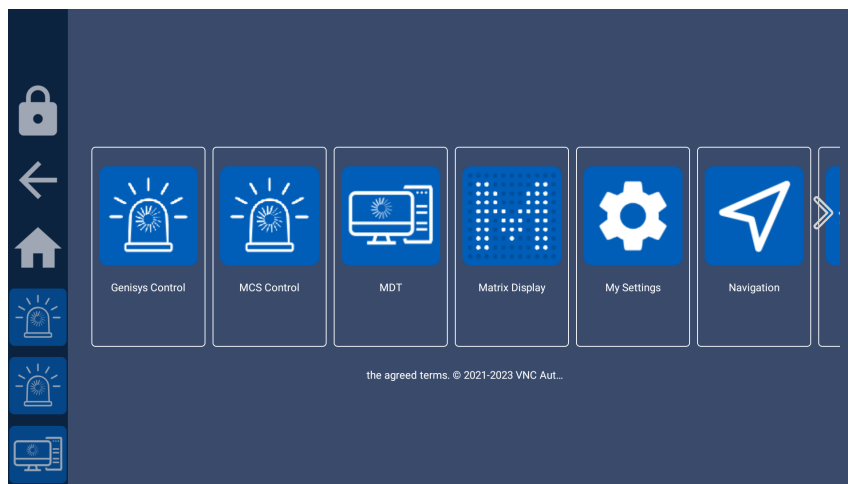

Figure 7: Cobalt Cube launcher

### 4.1 Accessing Cobalt Cube settings

The Cobalt Cube settings are accessed through a hidden menu on the main screen. This menu may be accessed by triple-tapping the bottom left corner of the main screen:





Figure 8: Area to triple-tap for Cobalt Cube settings

## 4.2 Settings PIN lock

The Cobalt Cube settings page is protected by a pin lock to prevent unwanted user tampering when the unit is deployed.

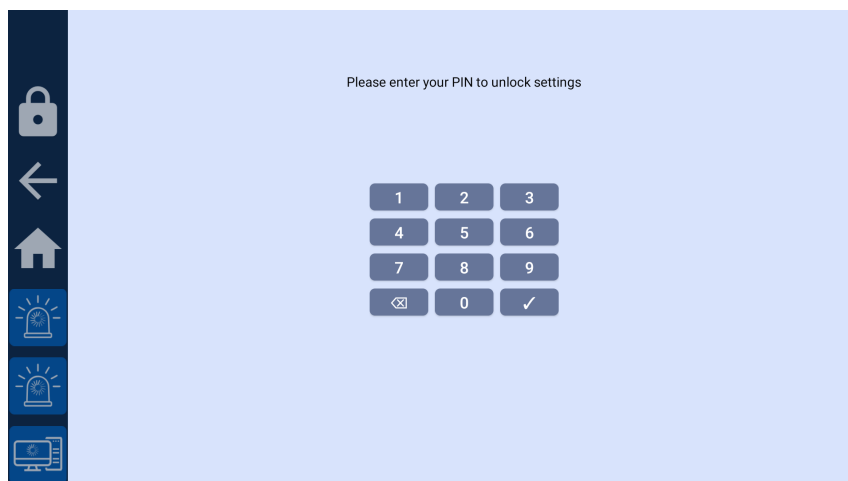

Figure 9: Settings PIN lock

The Cobalt Cube ships with a default pin code of: 2823

You can change this default pin once you access the settings menu.

**Note:** if you forget your updated pin there is no way to reset it.

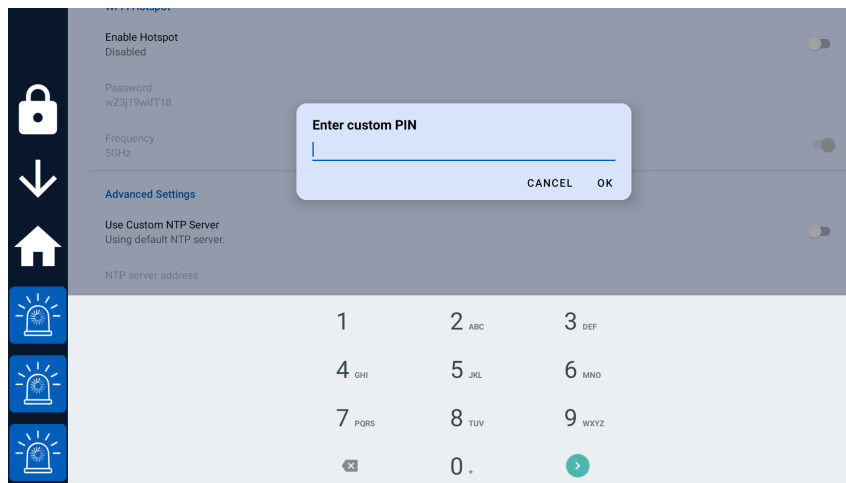

Figure 10: Custom PIN entry

### 4.3 Application specific settings

Some applications on the Cobalt Cube have their own settings menus. These can be found at the top of the Cobalt Cube settings page. A single tap on each listed icon will launch the settings for that app.

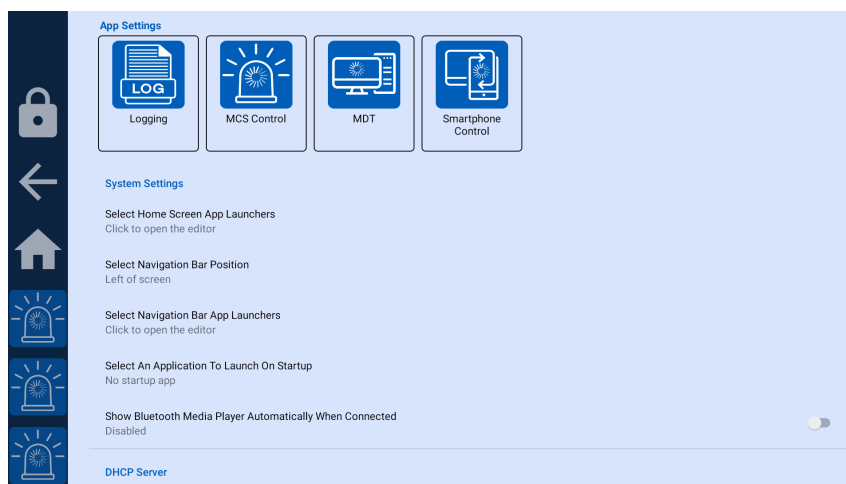

Figure 11: Application settings

### 4.4 Changing the display name for an application

Applications that support their own settings also support having their display name changed on the Cobalt Cube main screen. To enter a display name for an app, press and hold on the application icon at the bottom of the Cobalt Cube settings menu until the name change dialog appears.

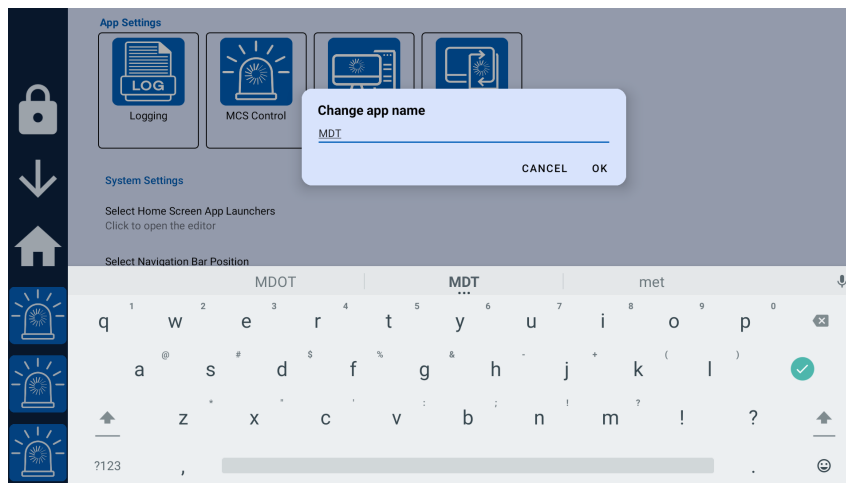
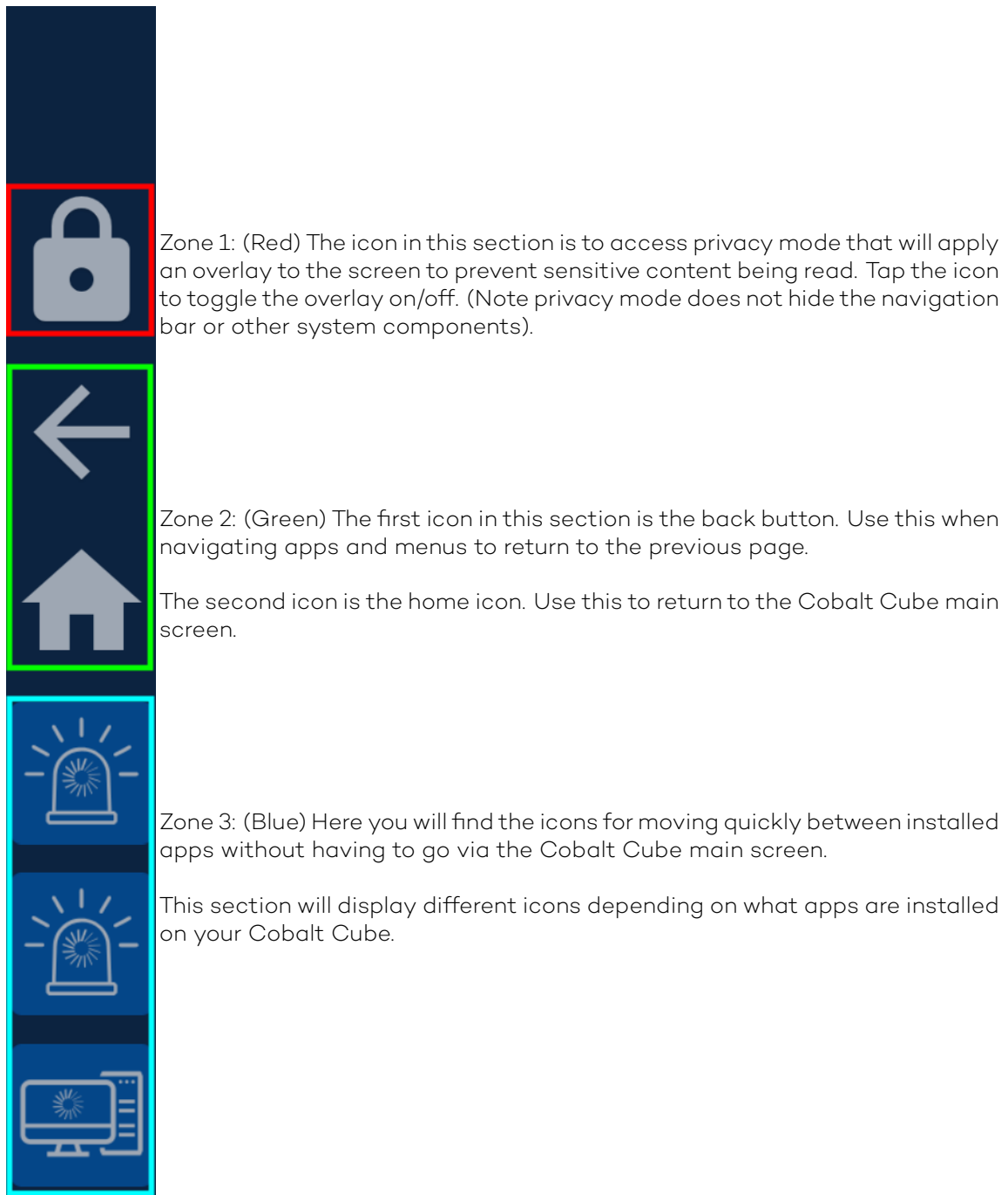

Figure 12: App name customisation

**Note:** The name of the Logging App will always be “Dump Logs” in the Cobalt Cube Launcher. This reflects the functionality of the app when shown in the launcher.

## 4.5 Navigation bar

The Cobalt Cube features a navigation bar that is divided into three zones:



#### 4.5.1 Position

The Cobalt Cube navigation bar can be configured in four possible ways. By default, the navigation bar is present on the left side of the screen. When changing the position of the navigation bar the following list of four options will be shown as in Figure 13.

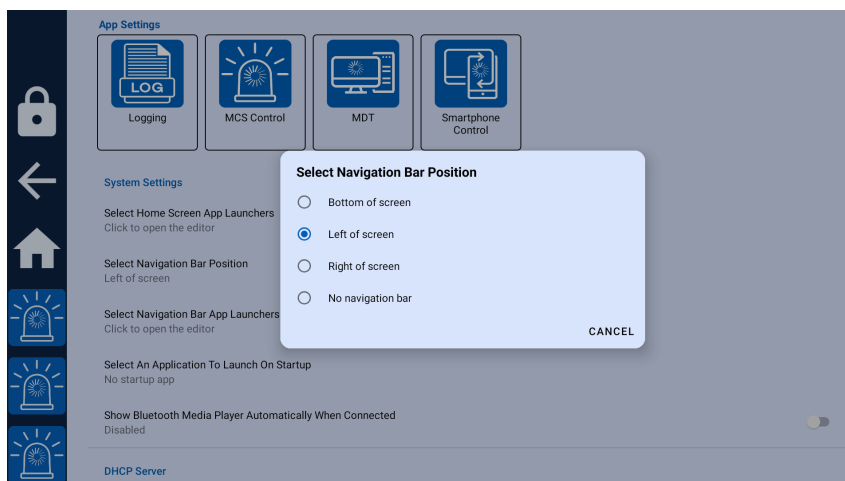

Figure 13: Navigation bar position dialog

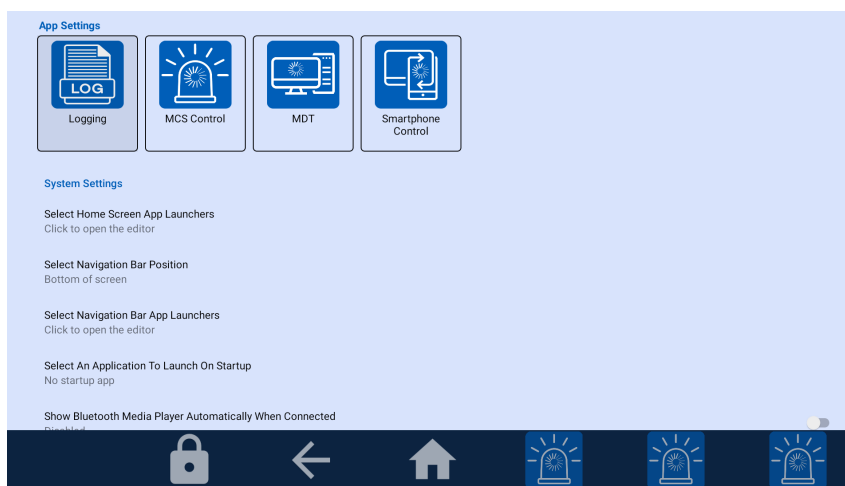

Figure 14: Navigation bar at the bottom of the screen

**Note:** Only applications pre-installed by VNC Automotive on the Cobalt Cube are guaranteed to be navigable when the navigation bar is hidden (done by selecting “No Navigation Bar” in the options). As such, we recommend that you keep the navigation bar visible and only turn it off if you have a specific reason to do so. Furthermore, when setting up your Cobalt Cube, disabling the navigation bar should be the last step you perform.

**Note:** If you choose to hide the navigation bar then navigation bar specific functionality such as “privacy mode” will be unavailable.

#### 4.5.2 Navigation bar quick launch apps

There are three spaces for app launchers in the navigation bar. By default, these are populated by VNC Automotive applications. They can be changed by clicking “Select Navigation Bar App Launchers”. A dialog will appear showing the apps currently in the navigation bar as well as the apps that could be added to it. Apps that are not currently in the navigation bar are greyed out. Tap the greyed-out app icons in the dialog to add them to the navigation bar, and the non-greyed-out icons to remove them.

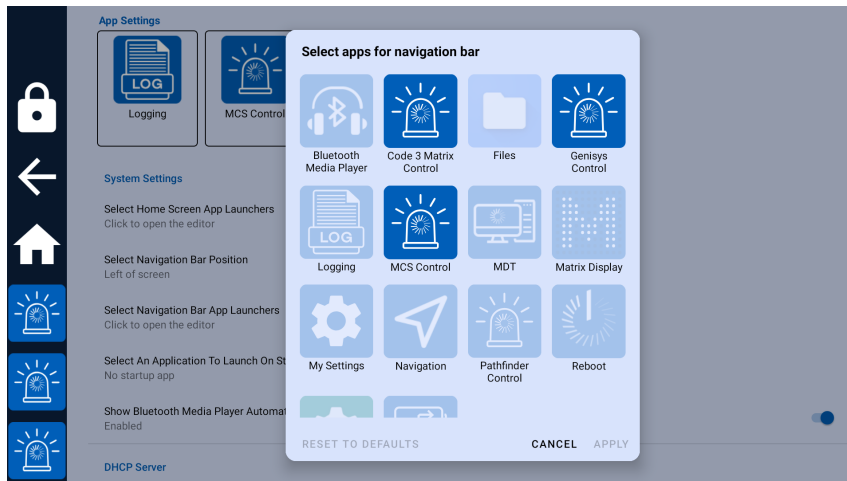

Figure 15: Navigation bar application picker

**Note:** The order in which apps are added to the navigation bar affects the order in which they are displayed.

## 4.6 Setting up the home screen

By default, the home screen is set up with all installed VNC Automotive applications listed in alphabetical order, except for Bluetooth Media Player and Logging. App launchers can be added or removed from the home screen by clicking the “Select Home Screen App Launchers” option. A dialog will appear with icons representing the apps that can be added to the home screen, which are greyed out, as well as apps that are already shown on the home screen, which are not greyed out. This dialog behaves in a similar way to the dialog for changing the apps in the navigation bar. Click the app icons in the dialog to select or deselect them. Selected apps will appear in the home screen once the changes are applied.

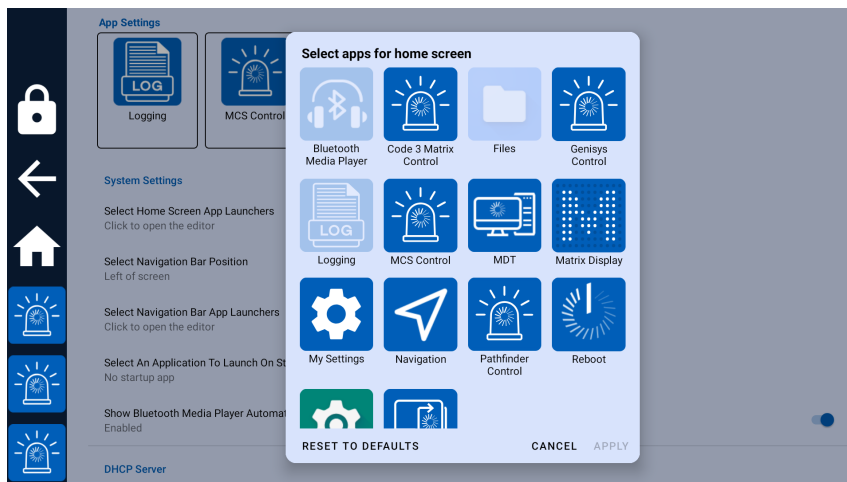

Figure 16: Home screen application picker

**Note:** By default, the System Settings application is hidden. You will need to enable it through this menu to access features like Bluetooth settings.

## 4.7 Setting a startup application

If there is an application that should open on startup, it can be selected in the “Select an application to launch on Startup” menu. By default, this is set to “No startup app”.

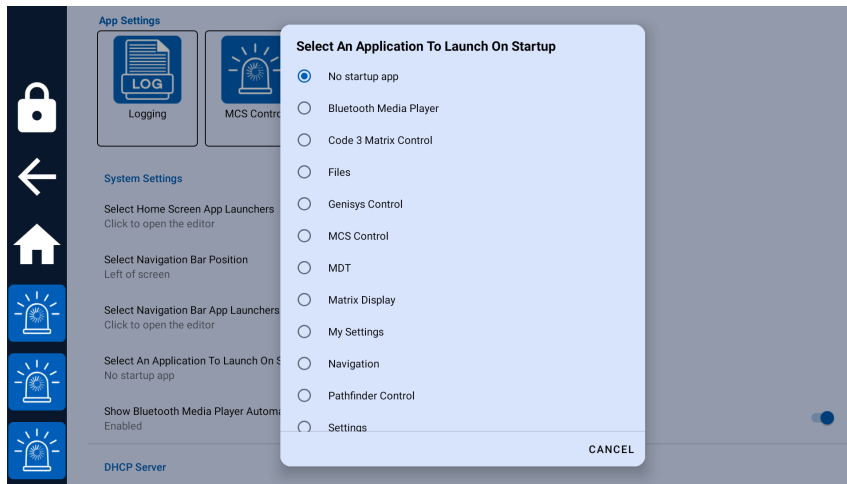

Figure 17: Startup application picker

**Note:** only apps shown on the home screen will appear in this menu. If an app is missing from this menu, add it to the home screen.

## 4.8 Setting a custom Network Time Protocol (NTP) server

The Cobalt Cube supports user defined NTP servers. Initially, three things need to be done before the custom NTP server will be enabled. First, the custom NTP server toggle under “Use Custom NTP Server” must be toggled on. Second, the “NTP server address” must be set to the desired IP address or domain name as seen in Figure 18. After both these steps are complete, the Cobalt Cube must be rebooted for the changes to take effect.

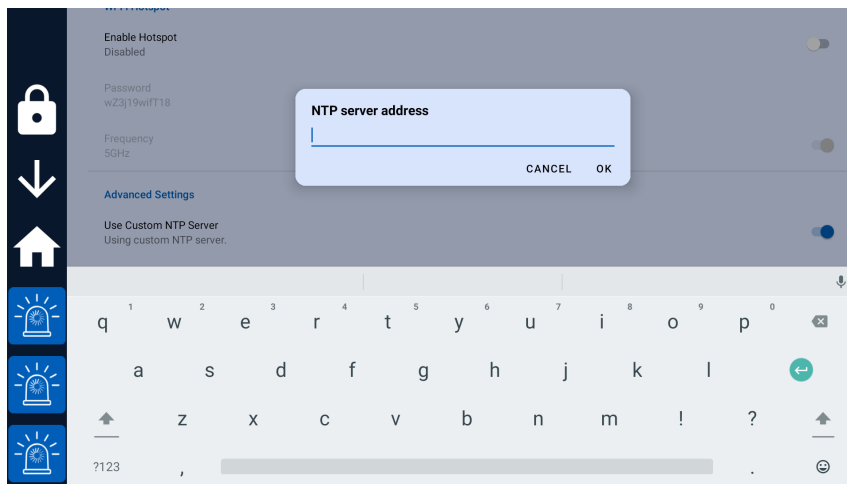

Figure 18: Choose custom NTP address

To disable the use of a custom NTP server the “Use Custom NTP Server” should be toggled off and the Cobalt Cube rebooted. There is no need to clear the address saved in “NTP server address” when disabling the custom NTP server. If an address is already present in “NTP server address” when “Use Custom NTP Server” is toggled on, then it will be applied after the subsequent reboot. When either the toggle is changed, or the address entered a prompt will show as in Figure 19. This shows the following options: “CANCEL CHANGES” which stops that change from being applied and returns you to the settings, “REBOOT LATER” will save the change so it will be applied on any later reboot and “REBOOT NOW” which immediately reboots and applies the change.

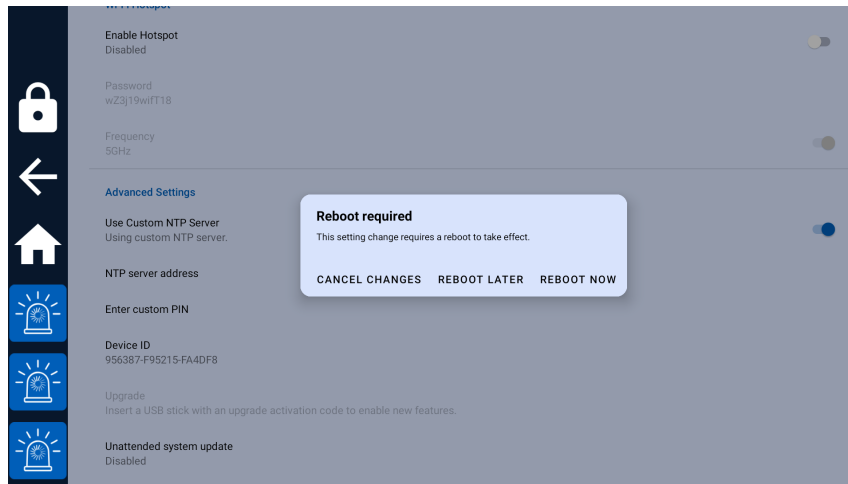

Figure 19: NTP reboot prompt

**Note:** The Cobalt Cube polls the custom NTP server once a minute. This allows the use of the server as a source of time-zone adjusted time, where large jumps are possible.

## 4.9 Phone call support

While the Cobalt Cube is connected to an IVI Display, a mobile phone handset can also be connected to the vehicle's head unit via Bluetooth. This allows call audio to be handled through the vehicle's speakers and microphones. For the widest compatibility with different vehicles and mobile phone handsets, Cobalt Cube has been designed to work alongside the pre-existing Bluetooth hands-free phone call support of the vehicle. For Cobalt Cube to run alongside a paired handset in the vehicle, a one-time setup process is required.

**Note:** Control over the call (making a call/picking up a call etc...) is dependent on the vehicle's IVI system and varies from vehicle to vehicle. Some controls in some vehicles may be disabled whilst Android Auto is active. One or more of voice command, steering wheel buttons, head-up display controls and central console controls may or may not be possible in your vehicle whilst Cobalt Cube is connected. When integrating Cobalt Cube in a new vehicle it may be instructive to run test calls and identify the supported functions for phone call handling.

### 4.9.1 Setup

The following steps should be followed to set up phone call support.

#### Step 1 - Link the phone to the Cobalt Cube

The first step is to link the phone with the Cobalt Cube. To do this the phone must have its Bluetooth turned on and be discoverable. Open "My Settings" and click "Selected Bluetooth handset" under the category of "Phone Settings". This brings up a pop-up which shows all discoverable Bluetooth devices within range of the Cobalt Cube, select the phone you would like to use (as seen in Figure 20).



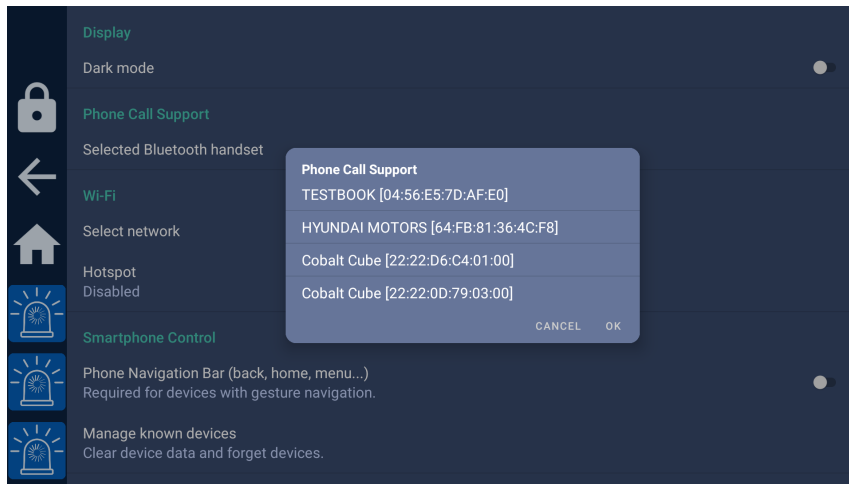

Figure 20: Linking a phone to the Cobalt Cube

Click “OK” to select the device that will be linked to the Cobalt Cube. To complete the linking procedure, the Cobalt Cube will need to be restarted. A pop-up will appear allowing an immediate reboot or a deferred reboot (see Figure 21). If the reboot is deferred, then the “Reboot” app will need to be used to reboot the Cobalt Cube before moving on to the next step.

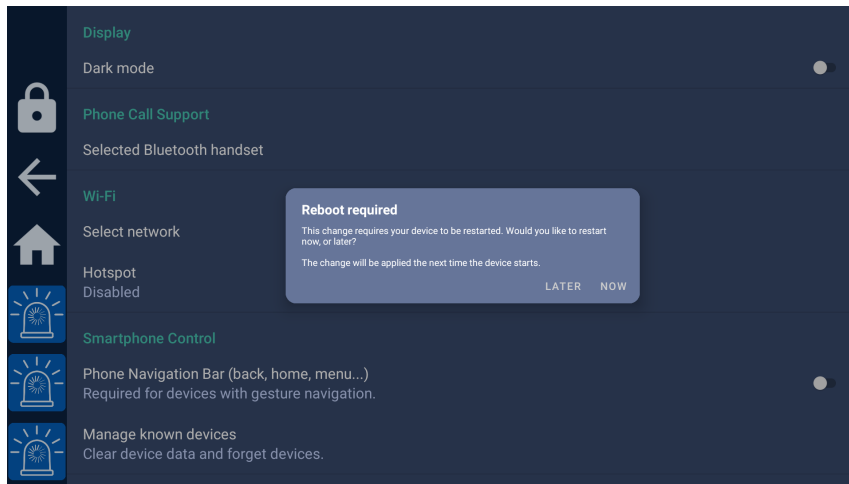

Figure 21: Post linking reboot prompt

### Step 2 - Pair and connect the phone to the vehicle

If the specified phone is already paired and connected to the vehicle, then this step can be skipped. If not, the phone needs to be paired and connected to the vehicle through Bluetooth. Ensure that the vehicle is selected as the device used for phone calls. Once this is done, all phone call audio will be routed through the vehicle.

**Note:** In a small number of vehicles, it has been observed that pairing cannot be done while the Cobalt Cube is connected, in this case, restart the Cobalt Cube and pair the phone while it is rebooting.

**Note:** Sometimes a vehicle will connect to the Cobalt Cube instead of or as well as the phone. The vehicle may attempt to route phone call audio from the Cobalt Cube instead of the phone. To avoid this, link the phone to the Cobalt Cube (Step 1). If the Cobalt Cube is paired to the vehicle after it has rebooted, unpair the vehicle and the Cobalt Cube. The vehicle will not re-pair with the Cobalt Cube.

## 4.10 Bluetooth Audio

The Cobalt Cube can act as a bridge between a Bluetooth capable device and the vehicle, enabling the audio from the device to be played through the vehicle's speakers.

### 4.10.1 Setup

The following steps need to be followed to enable the use of Bluetooth audio through the Cobalt Cube.

First the device must be paired with the Cobalt Cube. To do this, the device must have its Bluetooth turned on and be discoverable. The device and the Cobalt Cube can be paired through the "Settings" app (this can be shown on the home screen by following the instructions in section 4.6). To do this, open "Settings" and go through the following menus: "Connected devices" → "Pair new device". Then select your device and follow the instructions on the prompt. After the devices are paired, ensure that media audio is enabled for your device by opening the "Settings" app and selecting "Connected devices" → your device. The "Media audio" setting should be enabled as in Figure 22. If it is not, toggle the option so that it is enabled for this device.

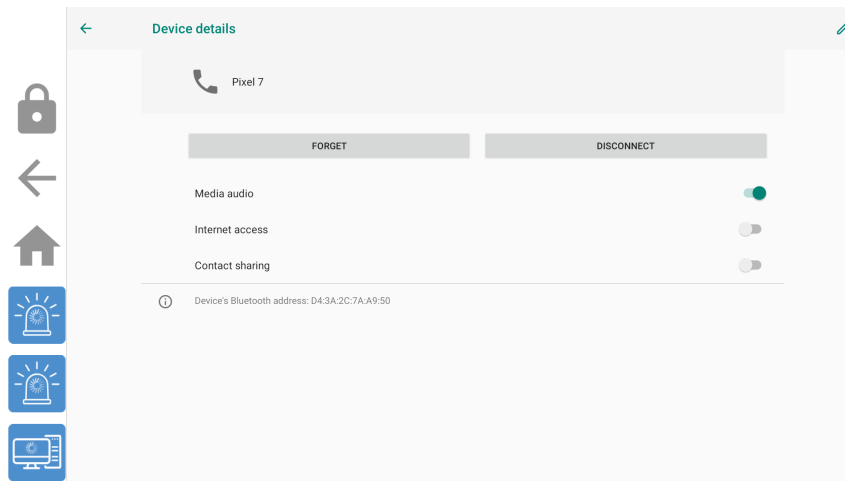

Figure 22: A Bluetooth device with Media audio enabled

**Note:** Multiple Bluetooth devices can be connected to the Cobalt Cube at once, however, only one should be enabled for media audio at a time as there is no way to select which one will be used.

### 4.10.2 Bluetooth Media Player

When another device is connected to the Cube and playing media audio, this audio can be controlled using the Bluetooth Media Player app on the Cobalt Cube. There are three ways to access the Bluetooth Media Player:

- Add the Bluetooth Media Player to the home screen (see section 4.6 for more details) and open the app as normal.
- Enable "Show Bluetooth Media Player Automatically When Connected" as seen in Figure 11 which will launch the media player when a Bluetooth media device is connected.
- Open it from the volume control bar by clicking the Bluetooth icon in the volume control bar (see Figure 23). The volume control bar is shown when the volume is changed on the Bluetooth media device.

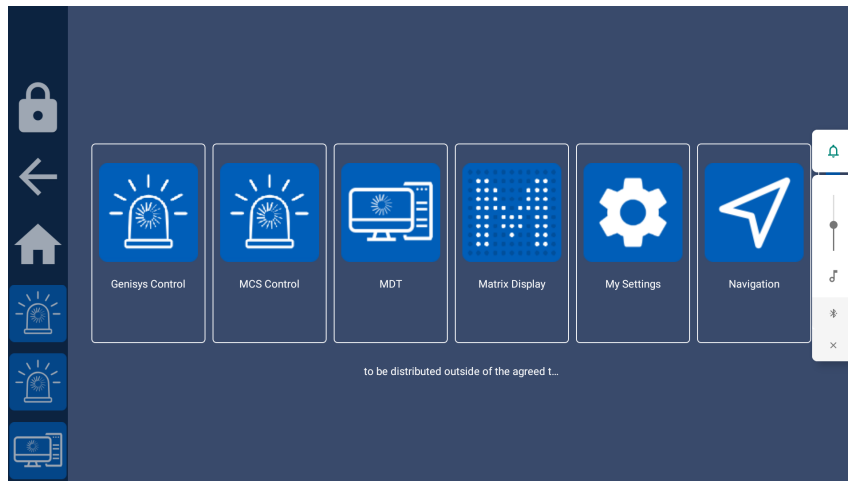

Figure 23: The volume control bar

The Bluetooth Media Player has two modes:

- Full-screen mode: Where the media player covers most of the screen, see Figure 24.
- Overlay mode: This is a smaller overlay at the top of the screen, see Figure 25.

Switching between these modes can be achieved by clicking the plus or minus buttons on the right-hand side of the Bluetooth Media Player, and it can be closed by clicking the adjacent “X” icon.

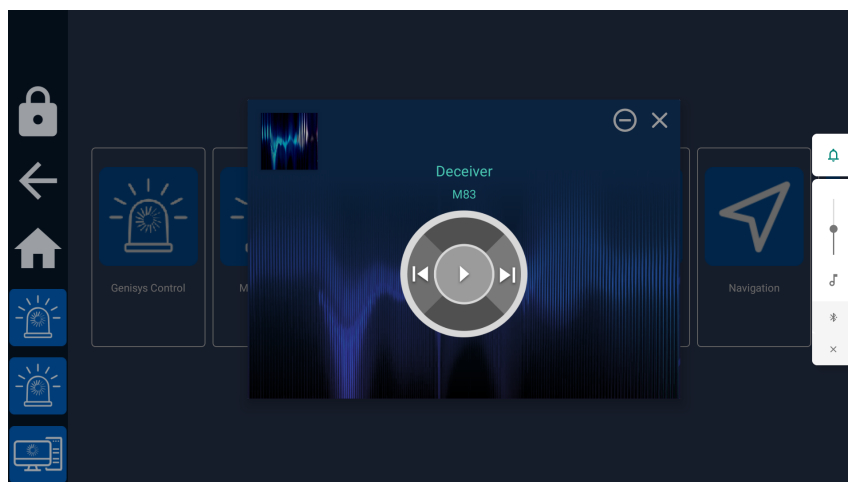

Figure 24: The Full-screen media player

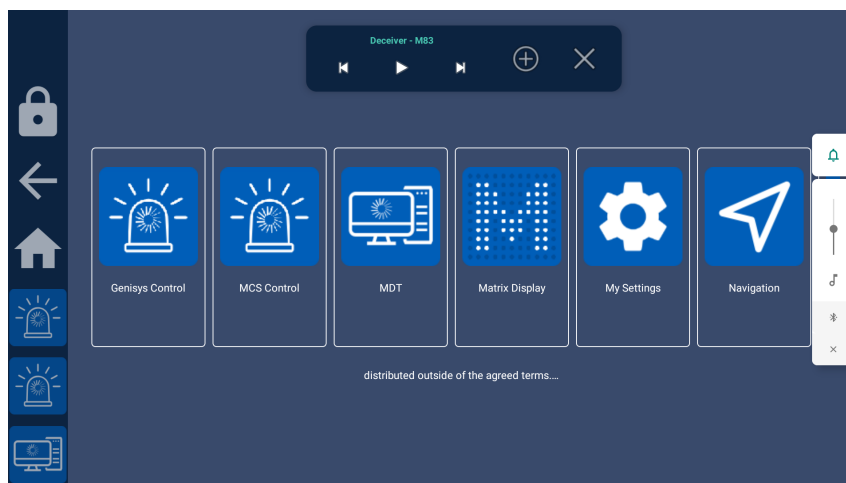

Figure 25: The media player in overlay mode

The play/pause, next and previous buttons can be used to control the media audio from the Cobalt Cube. However, these controls will not work for non-media audio such as navigation directions.

#### 4.10.3 Bluetooth Automatic Reconnect

The Cobalt Cube is able to automatically reconnect to any Bluetooth devices that it has previously been connected to. It will do this for 5 minutes after it boots, or until it successfully connects to a device, whichever is sooner. This means that a device that is paired with the Cobalt Cube and within Bluetooth range will automatically connect when the Cobalt Cube boots, without requiring any user intervention.

If, after the 5 minutes has passed, the Cobalt Cube has not been able to connect to any Bluetooth devices, it will stop attempting to connect automatically. In this case a Bluetooth connection will need to be manually initiated from either the Cobalt Cube or the other device by the user.

## 5 Updating the system image

The Cobalt Cube system can be updated easily. Security, compatibility and/or feature updates will be routinely provided during the lifetime of your product. For this you will only need a thumb drive and an update file provided by VNC Automotive.

**Note:** We recommend having an HDMI monitor connected to the Cobalt Cube while updating to allow you to monitor the progress of the update. While the update is in progress there will be nothing displayed through the car connection.

**Warning:** You must not remove the USB stick from the Cobalt Cube or interrupt the power while the device is being updated. If this happens it may render the device unusable, and it will have to be returned to VNC Automotive.

When updating a Cobalt Cube from a version older than v2.3.0.25, the update file will only be detected if it is called **update.zip**. If the version of the Cobalt Cube is v2.3.0.25 or newer, the only requirement is that the update file has a **.ccu** extension. Make sure file extensions are visible in the file browser before checking either of these cases.

Follow these steps to apply the update:

1. Rename the update file if necessary (see note above).
2. Copy the update file into the root directory of the USB thumb drive.
3. Insert the USB thumb drive into the Cobalt Cube HOST port.

4. After a few seconds, a dialog will pop up, notifying that an update has been found on the USB drive (see Figure 26). Select “Install” to install it.
5. The Cobalt Cube will install the update, and automatically reboot in the process. This may take a few minutes - do not remove the thumb drive or power off the Cobalt Cube until the process is completed.

**Note:** if the update process appears to be stuck on a black screen, press the reboot button on the Cobalt Cube. The button can be found on the same side as the HDMI port.

The Cobalt Cube will automatically display a dialog notifying of the successful update after it has been rebooted, and asking the user whether they want to delete the update file from the USB thumb drive, to prevent the process from starting again (see Figure 27). At this point it is safe to extract the USB thumb drive. Keeping the thumb drive plugged and not deleting the update file when prompted may cause the Cobalt Cube to offer to update again.

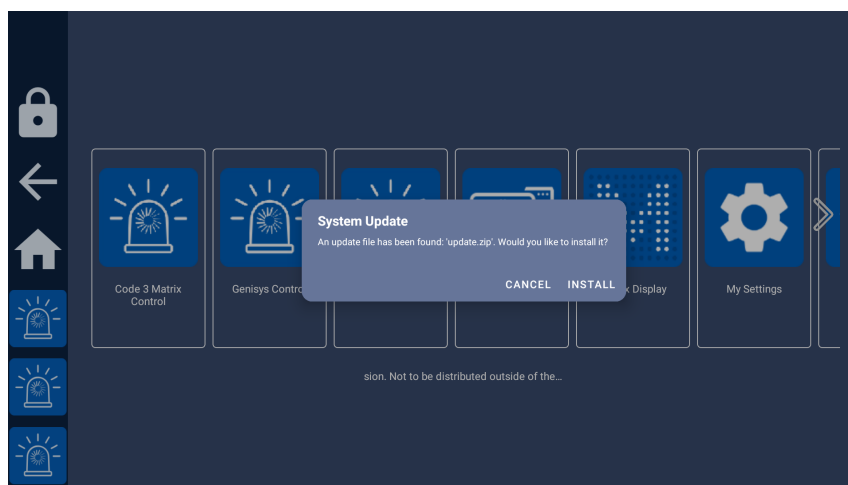

Figure 26: Update dialog

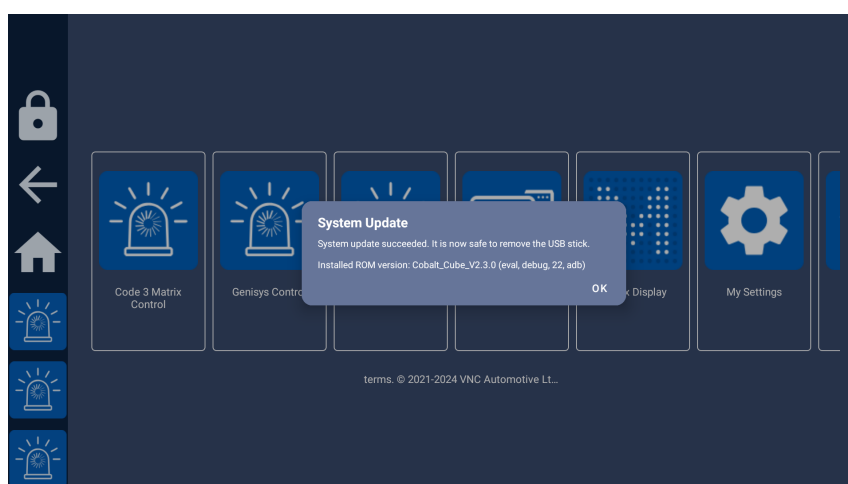

Figure 27: “Update successful” dialog

## 5.1 Rebooting the Cobalt Cube

In order to reboot the Cobalt Cube from the IVI screen, the Reboot app can be used. Clicking on the app opens a simple prompt as shown in Figure 28. Clicking “OK” on this will immediately reboot the Cobalt Cube, whereas selecting “CANCEL” will close the prompt and not reboot.

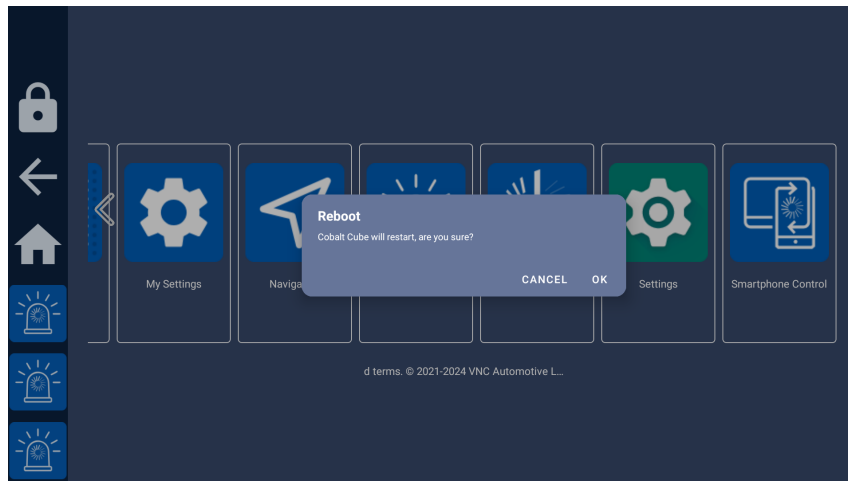

Figure 28: Cobalt Cube reboot prompt

## 5.2 Activating new features

If new apps or features have been purchased, they can be activated using the “Upgrade” option in hidden settings, under the “Advanced Settings” section. This is shown in Figure 29. To enable the option, a storage device with an activation code should be inserted into the “HOST” port.

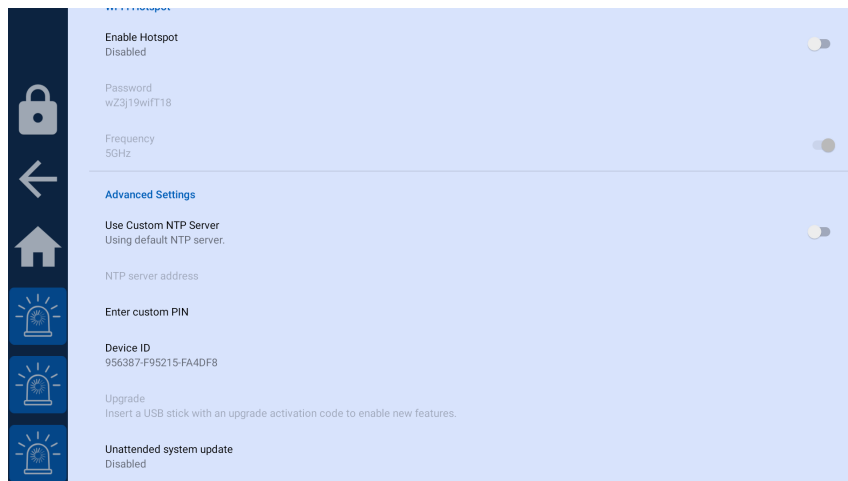

Figure 29: Upgrade option with no storage device inserted

When enabled, the upgrade option should appear as in Figure 30.

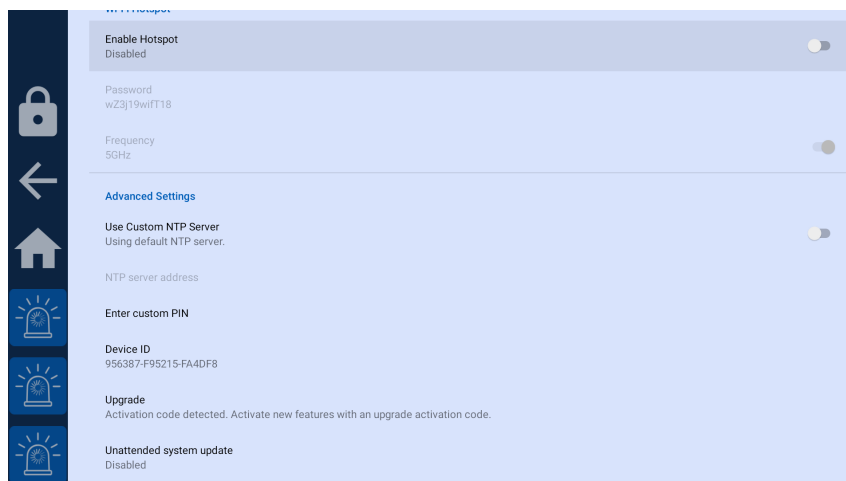

Figure 30: Upgrade option with activation code detected

Click the upgrade option to open the dialog shown in Figure 31. This should list the activation codes detected on the storage device. This will usually be only one. When the correct activation code is selected, click “UPGRADE”. This will apply the upgrade and activate any new purchased features.

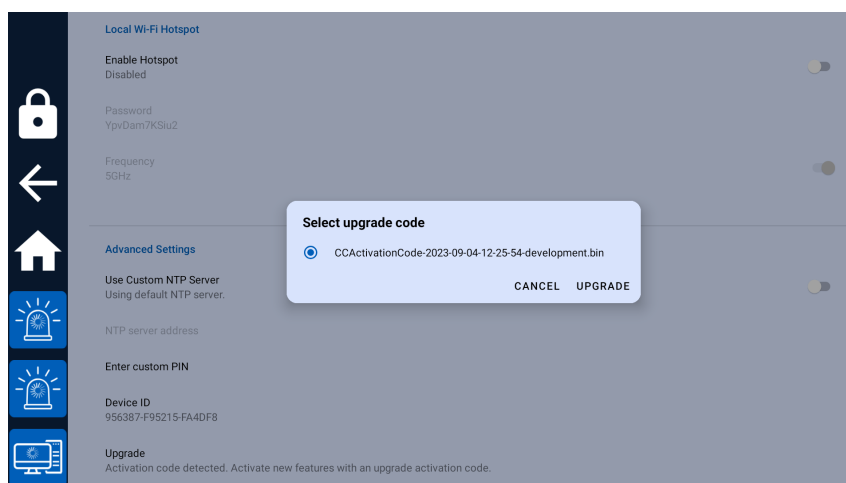

Figure 31: Upgrade option with activation code detected

Settings can also be applied in this step, to go along with any features that are activated.

## 6 Use case: MCS Control

### 6.1 Introduction

The MCS Control application is designed to work with MCS hardware and firmware from Standby® RSG, such as the MCS-32, MCS-16 and MCS-8.

The Cobalt Cube works in harmony with the existing MCS configuration tool from Standby® (see Figure 32). Each MCS is configured as before to have the desired handsets, inputs and outputs, via the Windows configuration tool provided by Standby®. The Cobalt Cube MCS Control application works by reflecting the existing handset configuration of each MCS. On application start, the software reads the handset configuration, via the USB-serial interface, and reflects the instantaneous state of each handset button and shows this on the equivalent User Interface (UI). This button state includes the button colour set for its on and off states and also if it is currently illuminated.

## 6.2 Additional hardware requirements

Apart from the Cobalt Cube, the following hardware is required:

- Standby® MCS unit.
- Standby® MCS CAN Bridge (includes USB cable to connect to the Cobalt Cube).
- MCS handset (optional).

## 6.3 Connectivity instructions

Figure 32 shows the connections between the Cobalt Cube, MCS components, and IVI system screen.

1. Connect the MCS Controller to the MCS CAN Bridge via the included cable, plugging into the local CAN port of the MCS.
2. Connect the Cobalt Cube to the MCS CAN Bridge, via the USB-A cable included with the MCS CAN Bridge. Use the USB Host port on the Cobalt Cube.
3. If required, connect the MCS Handset to the MCS CAN Bridge, via the adapter provided.
4. Connect the Cobalt Cube to the IVI screen, via the USB OTG port on the Cobalt Cube. A USB-A to USB-C cable is required for this connection.



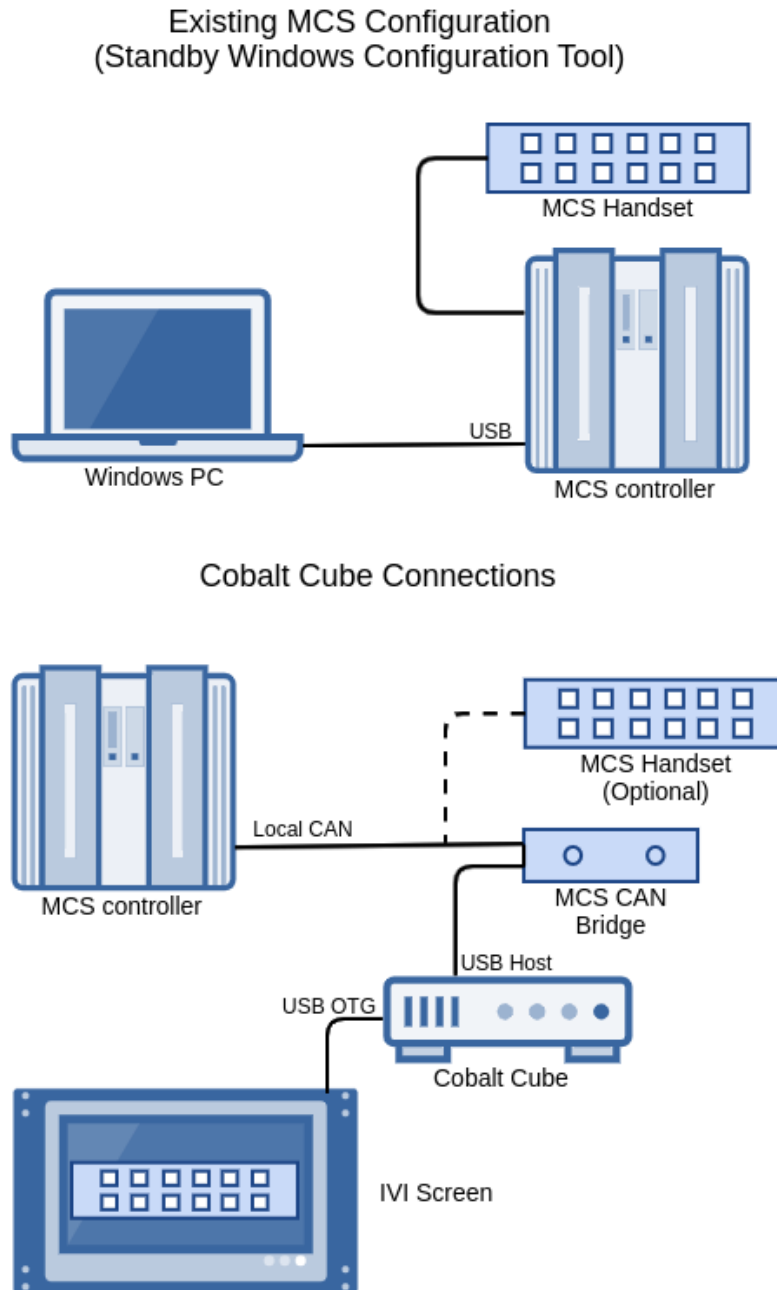

Figure 32: MCS Control connectivity diagram

## 6.4 Working with the MCS Control app

The MCS Control application can be run by tapping the “MCS Control” application icon from the Cobalt Cube app launcher screen, which appears on the IVI screen.

The UI for the handset can be individually tailored for your use case. For more information, please contact your VNC Automotive representative.

The following screenshots, for a typical T-16 handset, are provided as an example. Please note that the colours are for illustration purposes only, and in a real system would reflect the colours set in the MCS. Each button can be pressed on the vehicle’s IVI screen to operate the MCS in the same way that is done on the hardware handset. This operation happens with or without the hardware handset present in the vehicle.



Figure 33: Example UI (no buttons pressed)



Figure 34: Example UI (some buttons pressed)

Tapping the back arrow at the top left takes the user back to the Cobalt Cube app launcher screen.

Please note that if the MCS is not connected to the Cobalt Cube via the USB-CAN bridge, the following error will be shown:

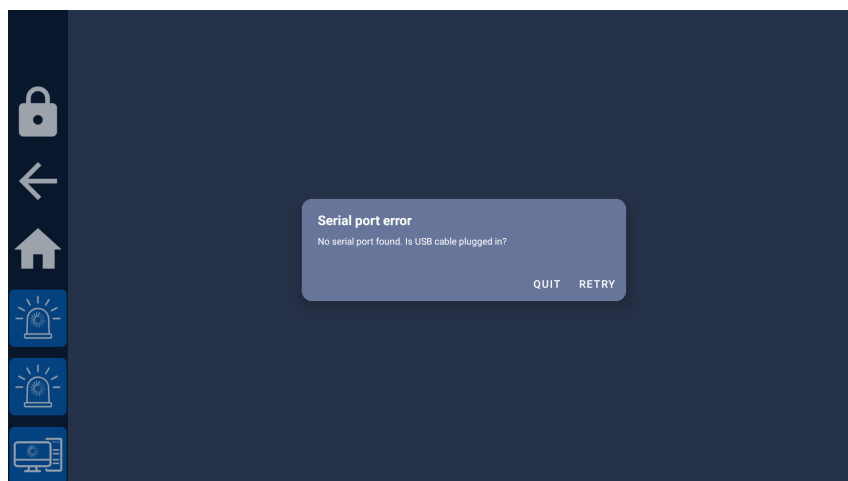

Figure 35: Error message when the MCS CAN Bridge USB cable is unplugged

In this case, check the USB Host port has the MCS CAN Bridge USB cable plugged in and tap “RETRY”. Tapping “QUIT” exits to the Cobalt Cube app launcher screen.

## 6.5 Configuring the MCS Control application

There is a configuration file for the MCS buttons at `/vnc/mcscontrol/`. The directory for the configuration will be created upon the launch of the main app or upon launch of the settings activity.

The MCS app will look for any file in the configuration directory that ends with a “.config” extension. If there is more than one file with that extension it will pick one to load. In this case the file is chosen arbitrarily in whatever order they are discovered by the application. You should not rely on this behaviour.

It is recommended that only a single configuration file called `mcs.config` is present in the configuration directory at any one time.

The file is a CSV file with the following layout:

```
<Handset ID>,<Button ID>,<Grid ID>,<Grid Position>,<Button Text>
```

Name	Possible Values	Description
<b>Handset ID</b>	0 - 127 inclusive	This is the value for the handset ID. This is typically 0.
<b>ButtonID</b>	0 - 127 inclusive	The ID of a specific button as configured in the MCS.
<b>Grid ID</b>	0 or 1	Specify if the button should be in the left grid of square buttons (0) or the right grid of rectangular buttons (1).
<b>Grid Position</b>	Grid ID 0: 0-11 inclusive. Grid ID 1: 0-1 inclusive.	The position in a grid that the button should be displayed. Indices start at the top left of a grid.
<b>Button Text</b>	Any text but must not contain a comma character.	The text to be displayed on the button.

If no configuration is specified, the application will use the following default preset:

```
0,15,0,0,Screen\nOn/Off
```

```
0,13,0,1,Inten\n-sity
```

```
0,11,0,2,Light\nBar
```

```
0,9,0,3,Run\nLock
```

```
0,7,0,4,Wing\nBlue
```

```
0,5,0,5,Siren\nOn/Off
```

```
0,14,0,6,Screen\nToggle
```

```
0,12,0,7,Rear\nReds
```

```
0,10,0,8,Cruise
```

```
0,8,0,9,H/L\nFlash
```

```
0,6,0,10,PTT\nPA
```

0,4,0,11,Siren\nToggle

0,2,1,0,9\n9\n9

0,0,1,1,PTT\nTetra

Configuration of these values is possible through the MCS settings application. See section 4.3 for details on how to access this.

Each row in the configuration file is represented by a row in the configuration application. Buttons can be modified, added and removed.

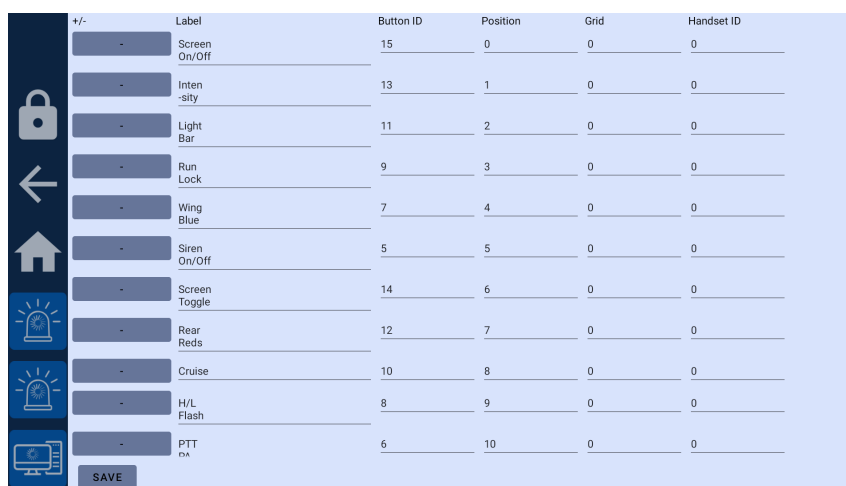

+/-	Label	Button ID	Position	Grid	Handset ID
-	Screen On/Off	15	0	0	0
-	Intensity	13	1	0	0
-	Light Bar	11	2	0	0
-	Run Lock	9	3	0	0
-	Wing Blue	7	4	0	0
-	Siren On/Off	5	5	0	0
-	Screen Toggle	14	6	0	0
-	Rear Reds	12	7	0	0
-	Cruise	10	8	0	0
-	H/L Flash	8	9	0	0
-	PTT PA	6	10	0	0

Figure 36: The configuration menu for the MCS Control app

## 7 Use case: MDT (Mobile Data Terminal) Control

### 7.1 Introduction

The MDT application is designed to connect with and control software running on a separate PC, laptop or tablet running Microsoft Windows. Different Cobalt Cube users in different first response scenarios can access essential applications such as Automatic Number Plate (Licence Plate) Recognition System (ANPR) software, or secure messaging and command control systems.

The Windows machine needs a compatible Cobalt Link+ server and to be on the same IP network.

Please refer to the Getting Started Guide for the Cobalt Link+ server for Windows for more information on how to set up Cobalt Link+ in the Windows machine.

**Note:** the MDT application can be renamed as appropriate to better match the function of the controlled Windows PC, which can make finding the right application to launch from the main list even easier for the user when in-vehicle. See section 4.4.

### 7.2 Additional hardware requirements

Apart from the Cobalt Cube, the following hardware is required:

- Windows PC running a Cobalt Link+ server.
- Router (wired or wireless).
- 2x Ethernet cables (only one is mandatory).

### 7.3 Connectivity instructions (Router)

There must be a network to which both the Windows PC and the Cobalt Cube are connected. The Cobalt Cube should be connected using an Ethernet cable (from its ETHERNET port) to the router; the Windows PC can be connected over Ethernet or Wi-Fi.

### 7.4 Connectivity instructions (Direct)

It is possible to connect the Cobalt Cube to the Windows PC directly without the need for a router if required. In order to facilitate this, both the Cobalt Cube and the Windows PC will require a static IP address in the same range. E.g. 192.168.1.10 for the Cobalt Cube and 192.168.1.20 for the Windows PC.

### 7.5 Assign static IP address for Ethernet adapter Cobalt Cube

On the Cobalt Cube, navigate to:

Settings > Network & Internet > Advanced > Ethernet > Ethernet Ip mode > static

You will then be prompted to enter your desired network settings.

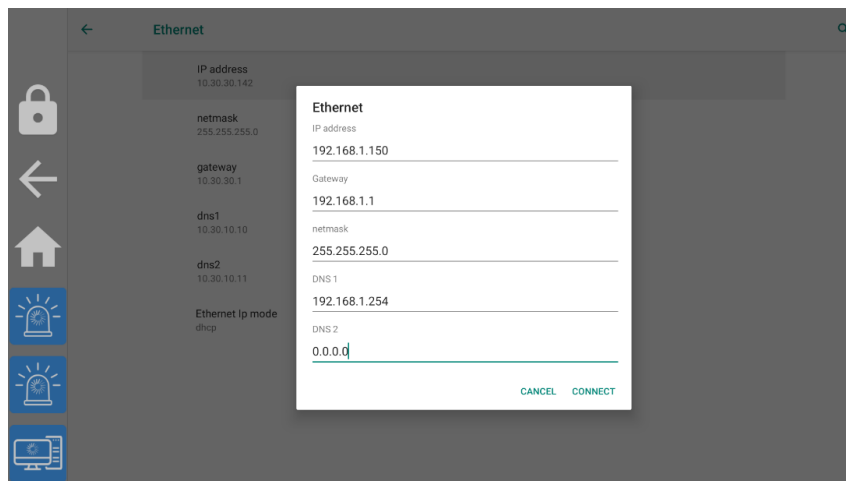

Figure 37: Cobalt Cube static Ethernet settings

When setting a static IP address on the Cobalt Cube, the Android system populates the entries with an example in grey text. These values are for guidance only and need to be re-entered manually, at which point they will show up as black text, as shown in Figure 37.

The “Connect” button will stay greyed out until each of the required entries has been entered.

### 7.6 Assign static IP address for Ethernet adapter Windows PC

From the desktop navigate to:

Settings > Network & Internet > Change adapter options

Right-click on the active Ethernet Adapter and select:

Properties > Internet Protocol Version 4 (TCP/IP) > Properties > Use the following IP address

You may then enter the desired network settings.

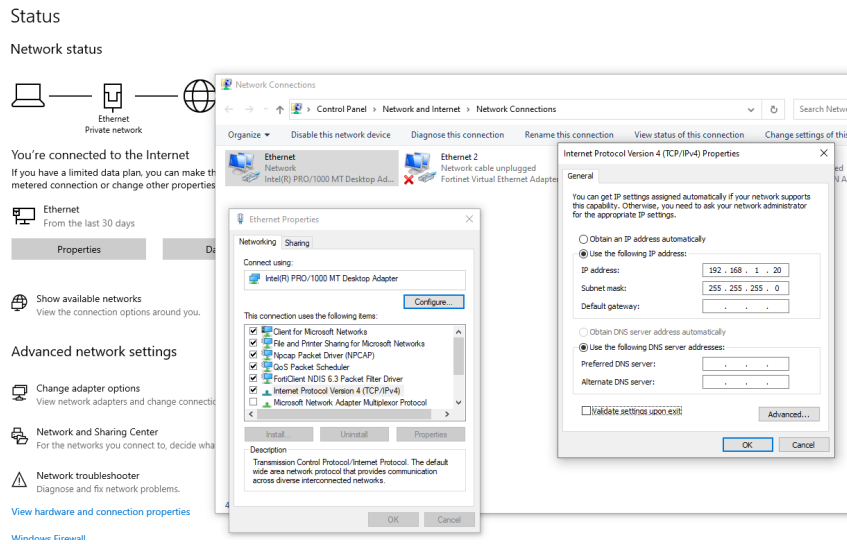

Figure 38: Windows PC static Ethernet settings

## 7.7 Working with the MDT application

After launching the application from the Cobalt Cube launcher by tapping the “MDT” icon, you will be presented with the following screen, and a connection will start automatically:

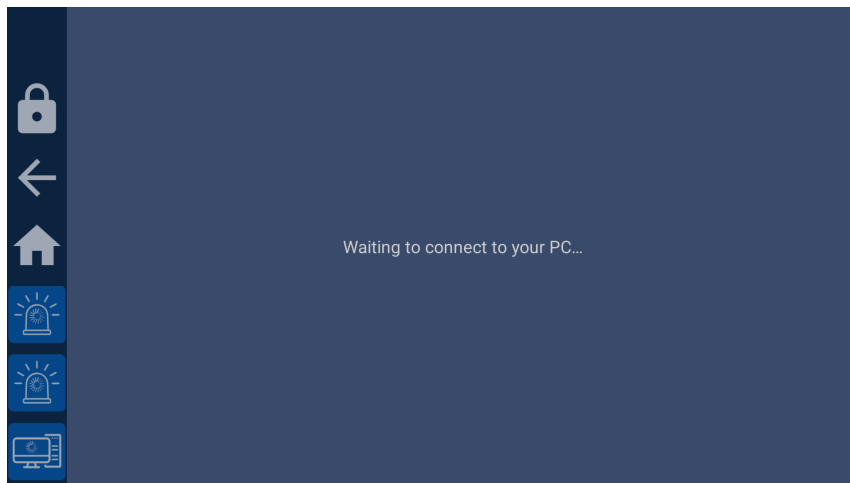

Figure 39: MDT Control screen

Once the connection is started, the Windows machine screen will be displayed on the Cobalt Cube, as shown in these examples:

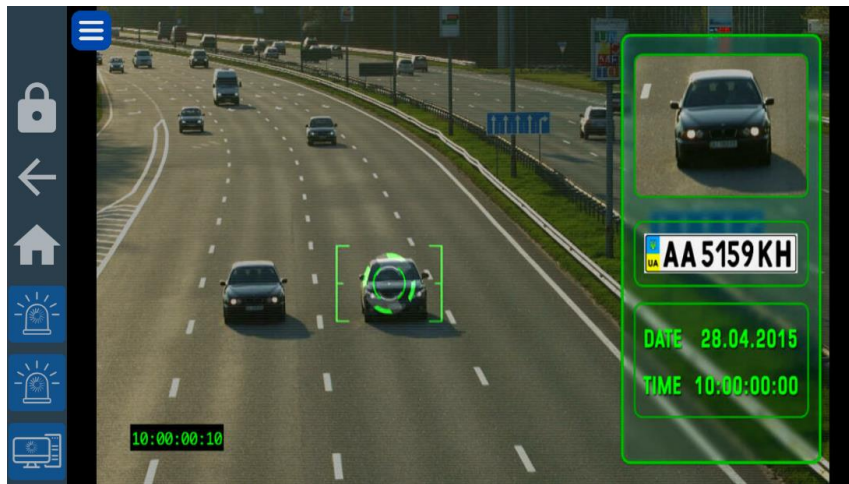

Figure 40: Example of projected MDT Control software

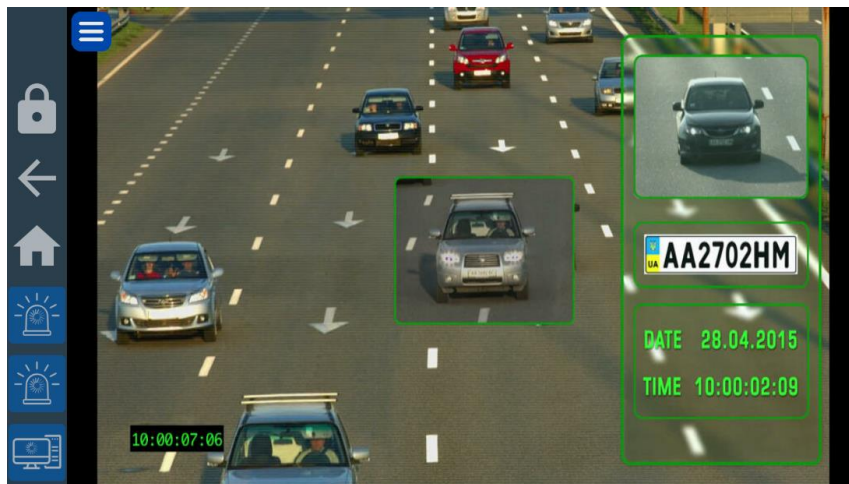

Figure 41: Example of projected MDT Control software

## 7.8 MDT configuration

The MDT application supports several configuration options via a file located at:

`/vnc/anprcontrol/config.properties`

Configuration options in this file are formatted using `<name>=<value>` syntax and are separated by new lines. E.g.:

```
scalingFactor=1
hideMenuBackButton=true
```

The full list of supported options is:

Name	Possible Values	Description
<b>commandstring</b>	<p>Any valid VNC Automotive command string.</p> <p>For connecting to a listening server:</p> <pre>vnccmd:v=1;t=C;a=&lt;server-ip&gt;;p=&lt;server-port&gt;</pre> <p>For listening for an incoming connection:</p> <pre>vnccmd:v=1;t=L;p=&lt;listening-port&gt;</pre>	<p>This value may be used to override the default behaviour of the MDT viewer and direct it to connect to a specific server or to listen for incoming connections.</p>
<b>hideMenuBackButton</b>	"true" or "false"	<p>If true, the floating back menu button will not be displayed in the application.</p> <p>Defaults to false.</p>
<b>scalingFactor</b>	Decimal values $\geq 1.0$	<p>Controls the scaling factor applied to the captured desktop before it is transmitted by the Cobalt Link+ Server.</p> <p>The scaling factor can be useful to save network bandwidth when using a smaller screen where a high resolution is not required.</p> <p><b>Note:</b> captured desktops can only be downscaled at this time.</p> <p>Defaults to 1.0.</p>
<b>encoding</b>	Must be one of: RAW JPEG TRLE	<p>Selects the encoding used by the Cobalt Link+ Server.</p> <p>Defaults to JPEG</p>
<b>fitToScreen</b>	"true" or "false"	<p>Controls if the Cobalt Cube will attempt to stretch the frame data to fill the available display space.</p> <p>Defaults to true.</p>



<b>setServerDisplayResize</b>	"true" or "false"	If true, the Windows desktop aspect ratio is changed to better match the head unit, to provide higher image quality.  Defaults to false.
<b>fileTransferEnabled</b>	"true" or "false"	If true, the Cobalt Link+ server will be able to transfer a system update file to the Cobalt Cube.  Defaults to false.
<b>fileTransferRateLimitEnabled</b>	"true" or "false"	If true, the System Update via Cobalt Link+ will be rate-limited. Without rate-limiting, an update file should be transferred under five minutes when using JPEG encoding. This can lower the frame rate by a few frames while the transfer is ongoing. If this is a problem, enabling rate limiting will prevent this, but the transfer can take up to an hour and a half.  <b>Note:</b> The transfer will take significantly longer using TRLE or RAW encodings regardless of rate-limiting.  Defaults to true.

**Note:** It is possible through the combination of turning off the navigation bar in the Cobalt Cube settings and setting "hideMenuBackButton" to true to have no button to exit MDT if it is actively connected. This can be desirable to maximise the amount of screen space available for the MDT application and to prevent accidental clicks outside the app.

However, to exit the app, the connection to the Cobalt Link+ Windows Server must be closed. Once the connection has ended the application can then be exited from the discovery screen via the back button in the top bar.

These settings can be changed using the configuration tool that can be accessed through the Cobalt Cube settings menu. For details on how to do this, see section 4.3.

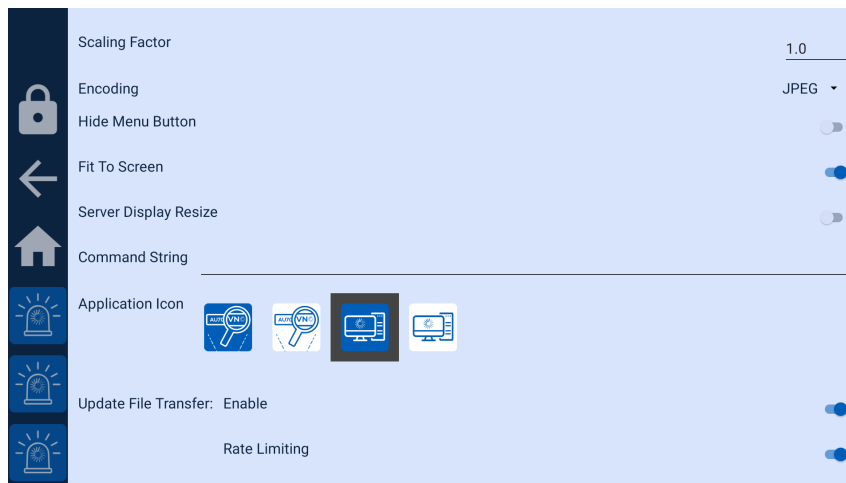

Figure 42: MDT settings

To create the configuration file manually, you will require the use of another computer. On that system create the file `config.properties` and add the desired options.

Copy the file `config.properties` to a USB memory stick and transfer that USB memory stick to the Cobalt Cube.

On the Cobalt Cube, select the “File Explorer” option in the “Select Apps” menu (See section 4.6). This will add the file browser application to the home screen.

**Note:** When you have finished, remember to hide the file browser application if it is not suitable for end users.

Open the Files application and select the three dots in the top right corner to access the menu. Choose “Show internal storage” from the options.

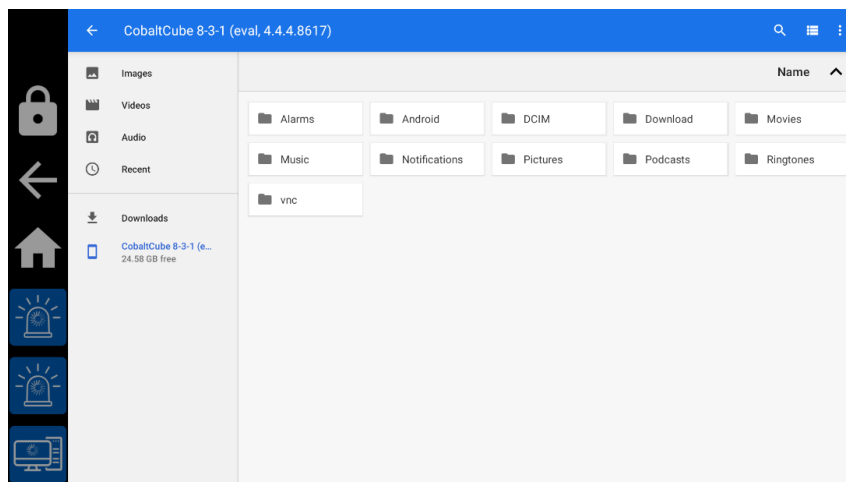

Figure 43: Files app showing internal storage and memory stick

Using the three-dot menu, create the directory structure `/vnc/anprcontrol` if it doesn't exist.

Copy the `anpr.properties` file from the memory stick to `/vnc/anprcontrol`. It is important that there is only a single file in this directory to avoid ambiguity over which configuration file MDT is using.

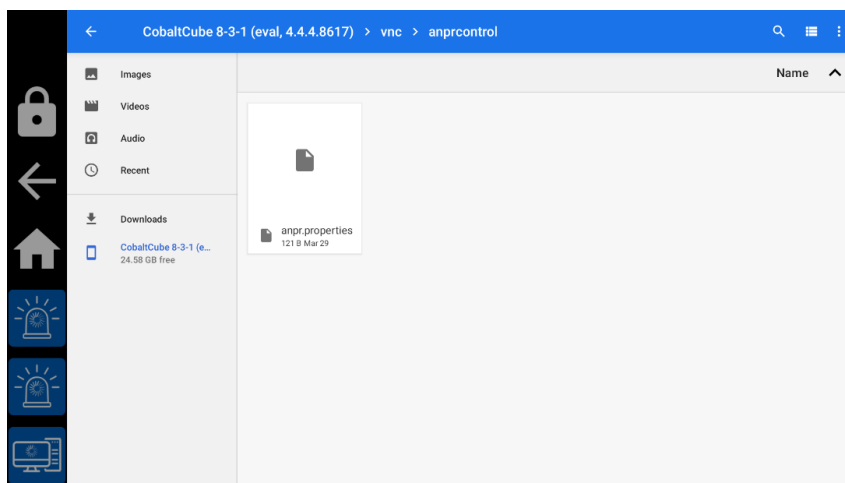

Figure 44: Files app showing the MDT configuration file

Remove the memory stick and return to the home screen.

## 8 Use case: Smartphone Control

### 8.1 Introduction

The Smartphone Control app is designed to be used in conjunction with iOS and Android devices that have the Cobalt Link+ app installed. This connection will allow you to view and control the apps running on your mobile device from the Cobalt Cube. For more information on the Cobalt Link+ apps for iOS and Android please contact your VNC Automotive sales representative.

### 8.2 Additional hardware requirements

In addition to the Cobalt Cube, an iOS or Android device running the Cobalt Link+ app is required.

### 8.3 Connectivity and set-up instructions

#### 8.3.1 Wi-Fi with Wi-Fi hotspot

Smartphone Control can control your device wirelessly via a Wi-Fi hotspot running on Cobalt Cube. Wi-Fi hotspot on Cobalt Cube is the preferred option for wireless control of the smartphone. This gives the integrator the option to keep a vehicle's router available as a separate network. The hotspot configuration also allows a mobile device in the vehicle to connect to both a mobile data network and the Wi-Fi hotspot provided by the Cobalt Cube.

**Note:** It is possible to set up a Wi-Fi hotspot on a smartphone as the basis of the network used for connecting the Cobalt Cube and the phone, however this approach has not been officially tested at this time.

Find the “Wi-Fi Hotspot” section in hidden settings and enable the hotspot.



Figure 45: Wi-Fi hotspot section

For regular users of the app once the vehicle is in service, the name and password of the created “Wi-Fi Hotspot” can be viewed, but not edited, in the My Settings app.



Figure 46: Wi-Fi Hotspot name and password

Once a “Wi-Fi Hotspot” is shown in the My Settings app, a mobile device can be connected to this hotspot, as shown in Figure 46.

For Android, it is important to connect to the hotspot using the Cobalt Link+ mobile app, rather than Settings. Connecting to the hotspot using Settings will cause the device to lose its mobile data connection. Enter the hotspot name and password into the Wi-Fi details dialog, which will appear when the broadcast button is pressed.

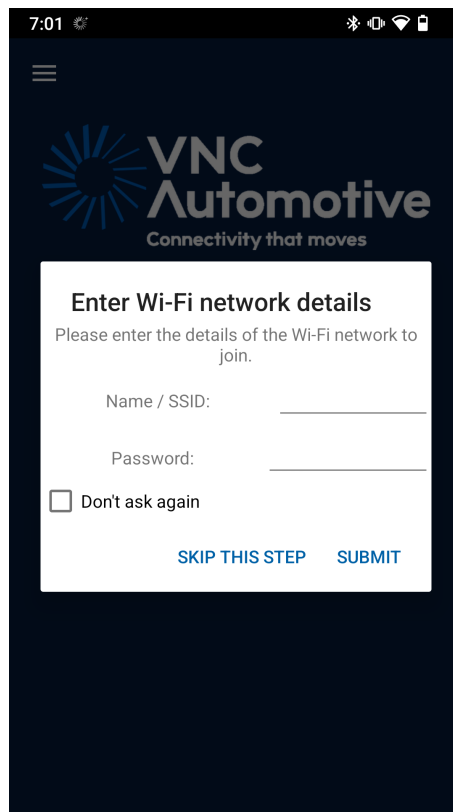

Figure 47: Cobalt Link+ app Wi-Fi details dialog

For iOS, connect to the hotspot using the Wi-Fi section in the Settings app. Select the hotspot by name from the list of networks.

### 8.3.2 Wi-Fi with Router

There must be a network to which both the mobile device and the Cobalt Cube are connected. The Cobalt Cube should be connected using an Ethernet cable from its “ETHER-NET” port to the router. The mobile device should be connected to the network in the same way as with a hotspot, using the Cobalt Link+ mobile app instead of Settings.

### 8.3.3 USB (Android only)

Android devices can be connected to Smartphone Control with USB. The mobile device must be connected from its USB port to the Cobalt Cube’s “HOST” port.

### 8.3.4 Working with the Smartphone Control app

Smartphone Control opens to the landing screen shown in Figure 48.

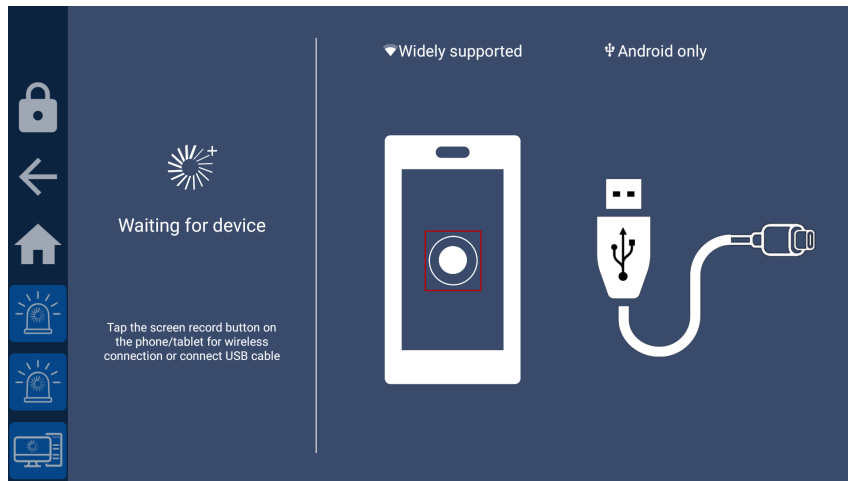

Figure 48: Smartphone Control Link+ device selection screen

Available mobile devices will appear on the right-hand side of the screen when they are detected. If no devices appear, make sure that your device is available for connection with one of the methods in section 8.3. For wireless connections, the mobile device must have the Cobalt Link+ app running (this can be in the background, and can be checked in the device's notifications). For USB connections, there must be a USB cable connecting the mobile device with the Cobalt Cube.

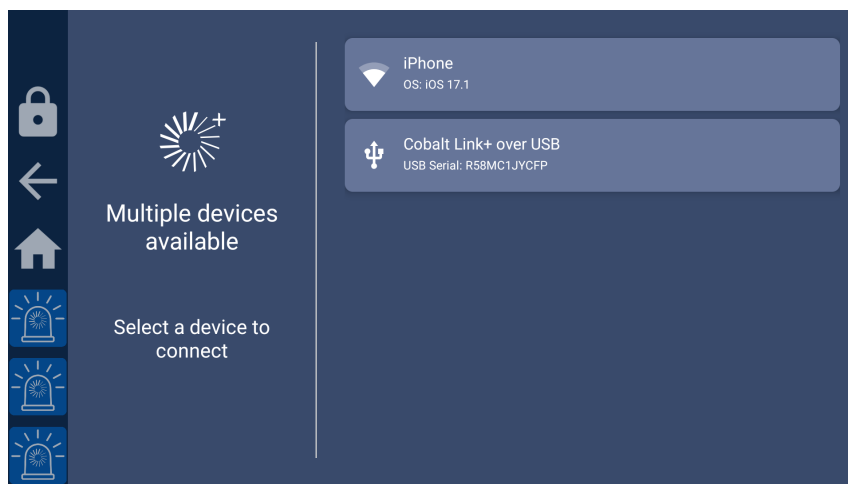

Figure 49: Multiple available Cobalt Link+ devices

The icon to the left of each device shows whether it will be connected with USB or Wi-Fi. Selecting a device will navigate forwards to Figure 50 if there are no devices currently paired, or Figure 51 otherwise. The mobile device is now connected for screen mirroring, but must also be connected via Bluetooth to enable remote control. It is important that Smartphone Control connects to the same device for mirroring and remote control. If a different device is selected for the Bluetooth connection, use the "Manage known devices" setting shown in Figure 57 to clear the device data.

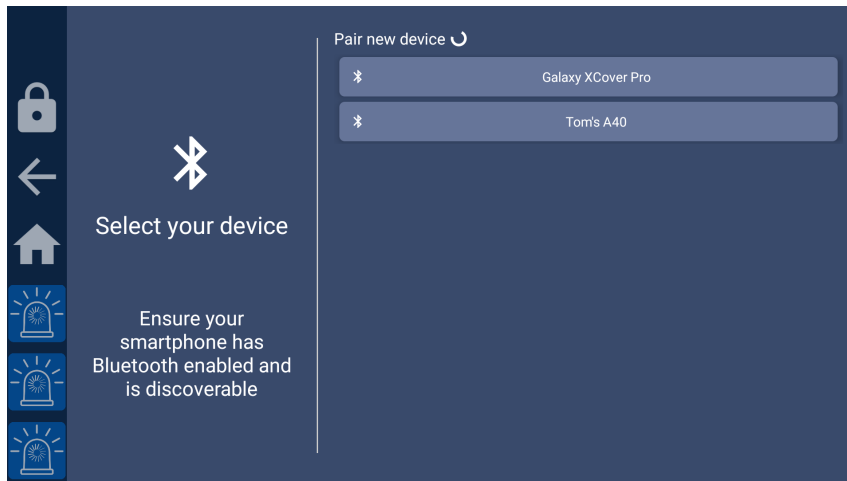

Figure 50: Bluetooth device selection screen when no devices are paired

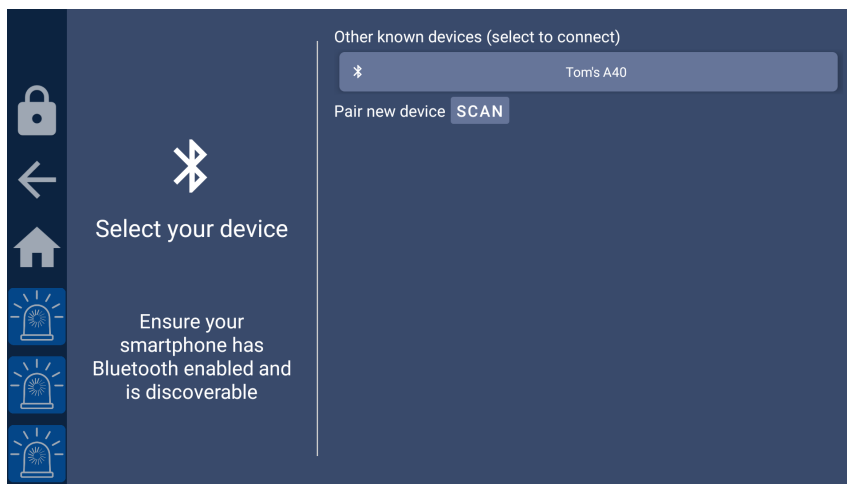

Figure 51: Bluetooth device selection screen when at least one device is paired

If a device is already paired, it can be selected in the “Other known devices” list shown in Figure 51. Otherwise, it will show in the “Pair new device” list. The “SCAN” button must be pressed for this list to populate if there are already paired devices. Selecting an unpaired device will cause Smartphone Control to attempt to pair it with the Cobalt Cube. This is shown in Figure 52.

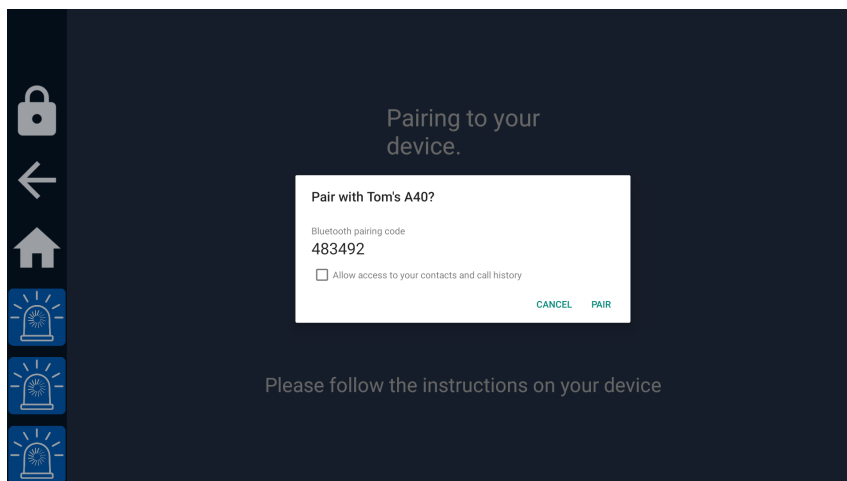

Figure 52: Bluetooth device pairing

After pairing to a new device, or selecting a known device, Smartphone Control will complete the connection. Follow the instructions on Smartphone Control and the Cobalt Link+ mobile app to begin screen mirroring.

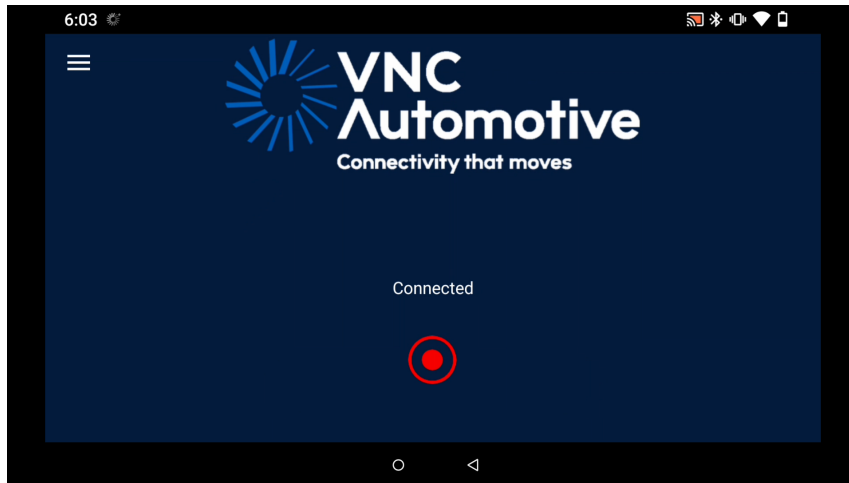

Figure 53: Projected device screen

To stop mirroring, press the broadcast button again if using Wi-Fi, or unplug the USB cable from the mobile device. Pressing back or home will only exit Smartphone Control, but the mirroring connection will be maintained in the background.

## 8.4 Auto-connection

When opened into the screen in Figure 49, Smartphone Control will automatically connect to known devices when they become available. The most recently connected device will be prioritised. The user will be alerted to the auto-connection by the text shown in Figure 54.

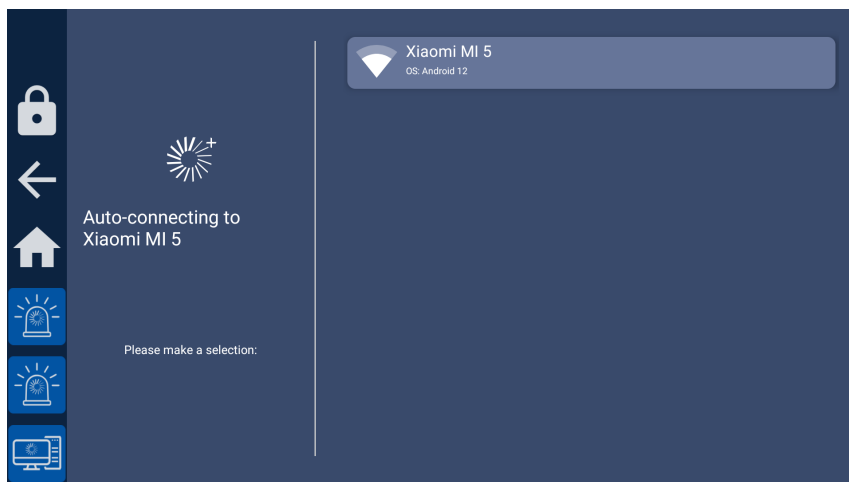

Figure 54: Smartphone Control Auto-connection

You do not need to do anything in this stage; Smartphone Control will automatically connect and start the session.

## 8.5 Authentication (optional)

For enhanced security, authenticated connections can be enabled by specifying credentials in the activation code (see section 3.2.2). This will require those same credentials to be entered in the Cobalt Link+ mobile app on first use.



This is an optional feature - however, leveraging authentication enhances the overall security of sessions. For those seeking assistance or specific password options, contacting the VNC Automotive sales representatives is recommended.

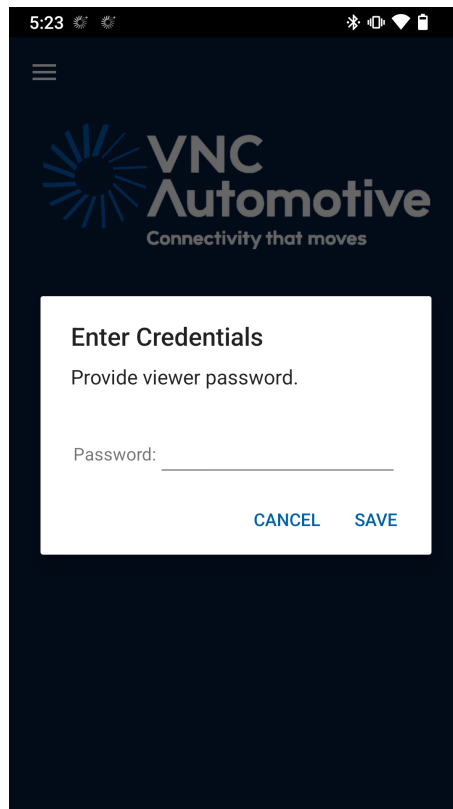

Figure 55: Cobalt Link+ app credentials entry

## 8.6 Smartphone Control settings

User-facing settings can be accessed in the My Settings app, shown in Figure 56.

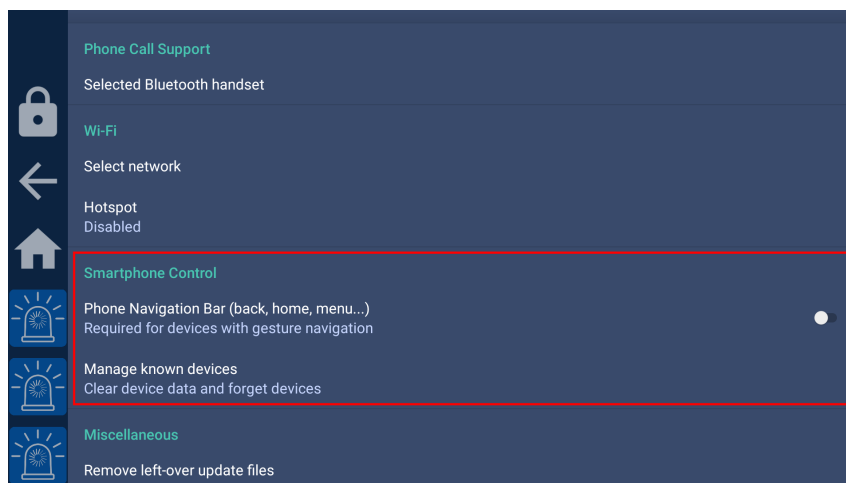

Figure 56: Smartphone Control app settings

### 8.6.1 Phone Navigation Bar (back, home)

This setting is used to enable virtual device keys for the connected mobile device. It is disabled by default, so you will not see any virtual device keys in projection unless you enable this setting.

### 8.6.2 Manage known devices

This setting is used to forget Cobalt Link+ devices which have previously been connected and/or clear their data (such as iOS device calibration data).

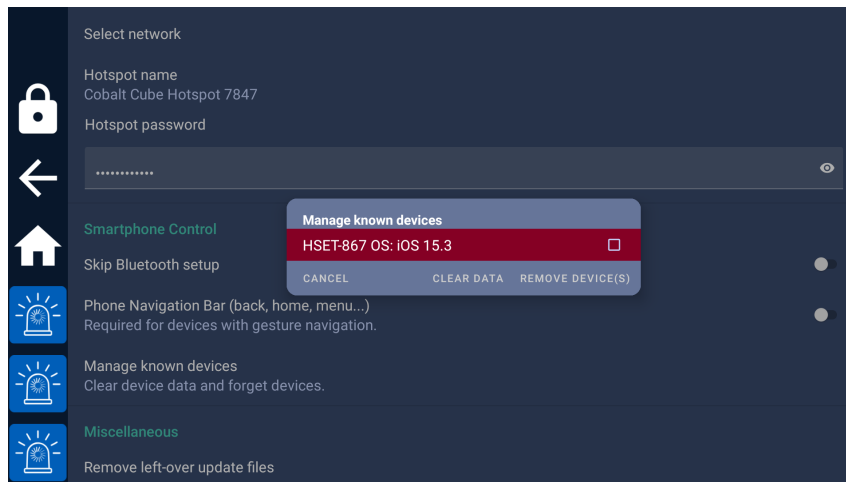

Figure 57: Manage known devices

“Clear Data” clears app specific data for iOS devices. “Remove device(s)” forgets devices for auto-connection and optionally allows Bluetooth unpairing (Figure 58).

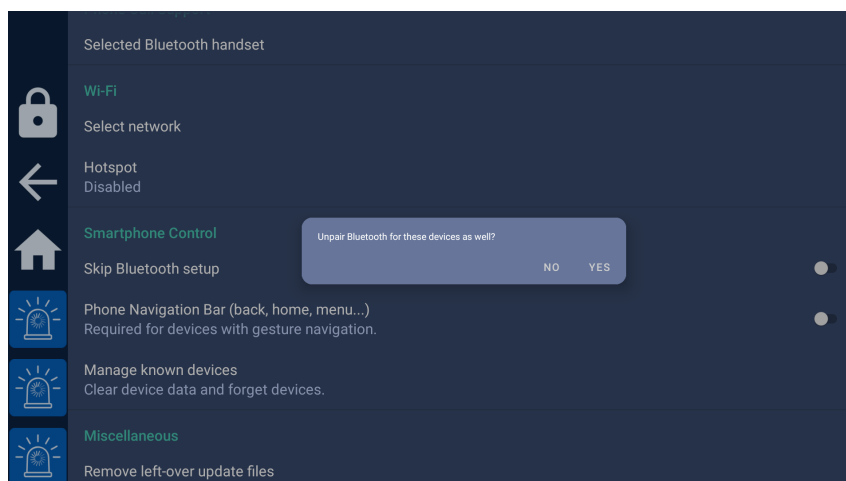

Figure 58: Unpair Bluetooth prompt

Admin-specific settings can be accessed through the Smartphone Control icon shown in Figure 11.

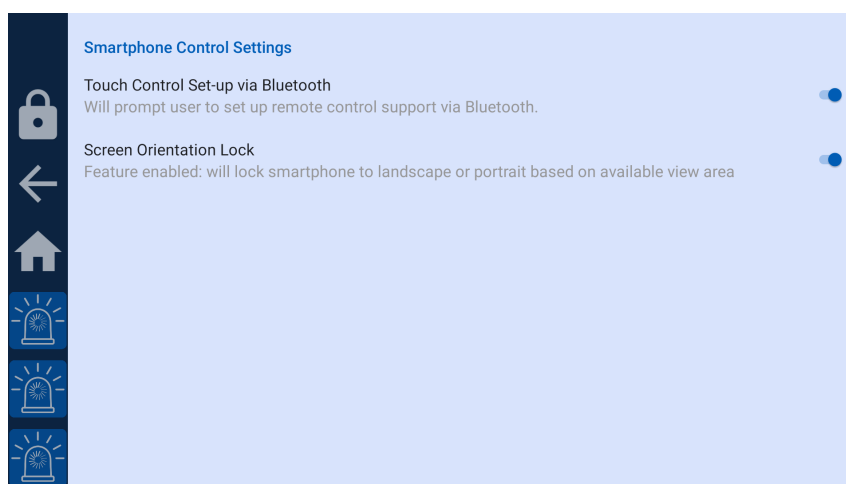

Figure 59: Smartphone Control app settings

### 8.6.3 Remote Control via Bluetooth

This is enabled by default, but if remote control of mobile devices from Smartphone Control is not required, this can be disabled. This will skip the Bluetooth pairing stage of the connection process, streamlining first-time connections.

### 8.6.4 Screen orientation lock

This is enabled by default, and will cause the mobile device to lock to the same orientation as the head unit. This allows the mobile device to make the most of the available screen space. Disable this setting to allow the device to determine its own orientation.

## 9 Use case: Genisys Control

### 9.1 Introduction

The Cobalt Cube Genisys Control application is designed to work with Ring Carnation's Genisys hardware and firmware, which is pre-programmed for each set of vehicles.

The Genisys Control application works with the existing configuration of the Genisys Controller.

On application start, the software reads the handset configuration, via the USB-serial interface, and reflects the instantaneous state of each handset button, or combination of buttons, and shows this on the User Interface (UI).

### 9.2 Additional hardware requirements

Apart from the Cobalt Cube, the following hardware is required:

- Protocol Converter module from Ring Carnation. This must be flashed with the standard Ring Carnation firmware, and provide an available RS232 port, which will be connected to the Cobalt Cube. The address ID on the module must be set to 4.
- RJ11 to USB converter, which can be purchased from Ring Carnation. The converter consists of two connected cables: RJ11 to RS232 and RS232 to USB.
- Genisys Controller from Ring Carnation.

### 9.3 Connection instructions

The diagram below shows the connections between the Cobalt Cube, Genisys components, and IVI screen.

Connect the Genisys Controller to the Genisys Protocol Converter, via the included cable, following existing instructions from Ring Carnation. Connect the Cobalt Cube to the Genisys Protocol Converter module, via the RJ11 to USB converter cable. Use the RS232 port on the Genisys Protocol Converter module and the USB Host port on the Cobalt Cube.

If required, connect the handset to the Genisys Protocol Converter, via the RJ11 cable provided.

Connect the Cobalt Cube to the In Vehicle Infotainment (IVI) screen, via the USB OTG port on the Cobalt Cube. A USB-A to USB-C cable of the appropriate length is required for this connection.

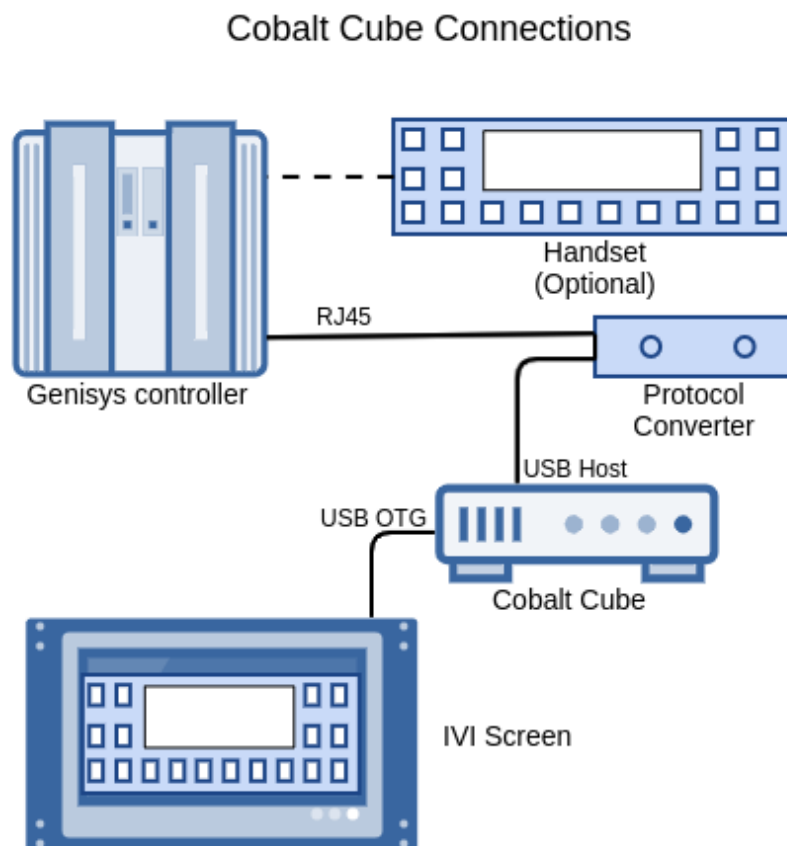

Figure 60: Cobalt Cube connections

## 9.4 Operating instructions

The Genisys Control application can be run by tapping the “Genisys Control” application icon from the Cobalt Cube app launcher screen, which appears on the IVI screen.

The UI for the handset is individually tailored for each customer and follows the same layout as the hardware handset. Each button can be pressed on the vehicle’s IVI screen to operate the Genisys Controller in the same way that is done on the hardware handset. This operation happens with or without the hardware handset present in the vehicle.

When the navigation bar is disabled, tapping the back arrow at the top left takes the user back to the Cobalt Cube app launcher screen.

The screenshots in Figure 61 and Figure 62 show representations of the UI with buttons on and off.



Figure 61: Genisys Control buttons off



Figure 62: Genisys Control with some buttons on

If the Genisys system is not connected to the Cobalt Cube via the USB-serial cable, the error in Figure 63 will be shown.

In this case, check the USB Host port has the USB cable plugged in and tap retry. Tapping “QUIT” exits to the Cobalt Cube app launcher screen.

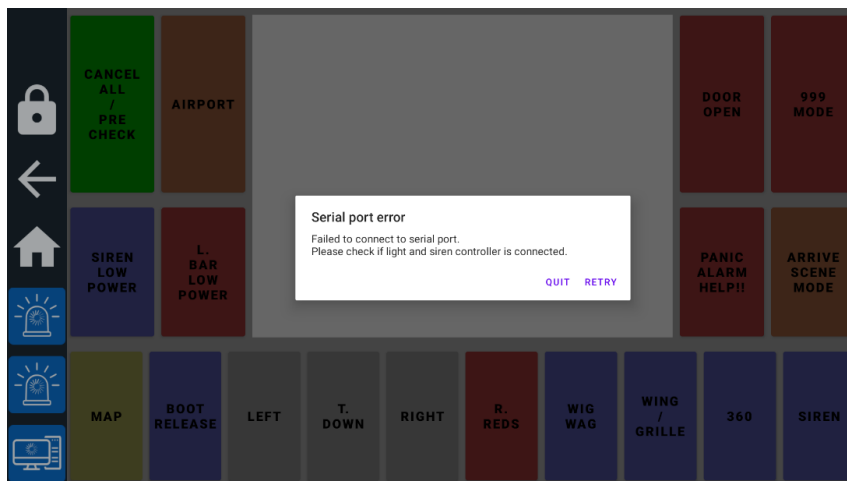

Figure 63: Serial port error

## 10 System utilities

### 10.1 Extracting system logs

From time to time, inconsistencies or other undesired behaviour with Cobalt Cube may be noticed by users during normal operation. The device now comes with built-in system log capture. This is a tool intended to be used by technical support agents via suppliers or vehicle fitters so that detailed information about the state of the system at the present time, or over a historical period, can be extracted and sent away for analysis.

The built-in logger is a support feature and is not intended for vehicle users during day-to-day functioning of the Cobalt Cube. This section covers the Logging app, which allows the Cobalt Cube to save logs that can be sent to VNC Automotive in the event of an issue.

#### 10.1.1 UI overview

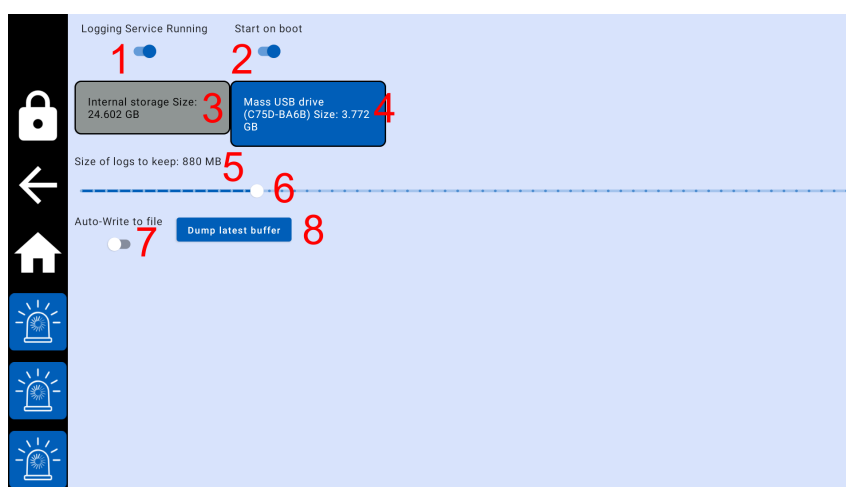

Figure 64: Logging app settings

1. Logging Toggle
  - i. This toggles the logging feature on or off. When this is off, no logs can be written manually or automatically.
  - ii. When this is on, the other logging features are available.
2. Start on Boot Toggle
  - i. When this is enabled, Logging will start on boot using the same configuration as before the Cobalt Cube was rebooted.
  - ii. When this is disabled, Logging will not start up automatically on boot.
3. Selected storage device
  - i. The storage device highlighted in green is where the log files will be written to. The size next to the device is the maximum space the log files can take up on the device.
  - ii. Internal Storage corresponds to `/vnc/logging/`.
  - iii. Devices are selected or unselected by tapping on them.
4. Other storage device
  - i. The greyed-out storage devices are unselected and will not have any logs written to them.
5. Size of logs to keep

- i. This is the maximum size all the log files on a device will cumulatively take up. E.g., if this is set to 1GB then up to 1GB of log files will be written, before the oldest log files will start being overwritten to ensure the total size does not exceed 1GB.
  - ii. The minimum size is 19MB.
6. Size of logs slider
  - i. Moving this left decreases the size of logs to keep and moving it to the right increases the size of logs to keep.
7. Auto-write logs
  - i. When enabled, logs will be written to the storage device every few minutes automatically without user interaction.
  - ii. When disabled, logs are recorded only when user initiated, or when the Cobalt Cube disconnects from the car head unit.
8. Dump latest buffer
  - i. This immediately writes a log file to the selected storage device.
  - ii. When pressed a toast will appear indicating whether the writing was successful or unsuccessful.

### 10.1.2 Additional information

- It can take 1-2 minutes for Logging to start up after boot.
- Do not turn off the Cobalt Cube or remove the selected storage device after manually dumping logs until the result has been indicated.
- If a valid storage device is not selected, the Logging service will be unable to save logs.
- The storage devices must be formatted to FAT32 and have a minimum size of 19MB.
- On USB storage devices the log files are written to `/Android/data/com.vncautomotive.logging/files/`.

### 10.1.3 Enabling logging

- 1) Enable the Logging service:

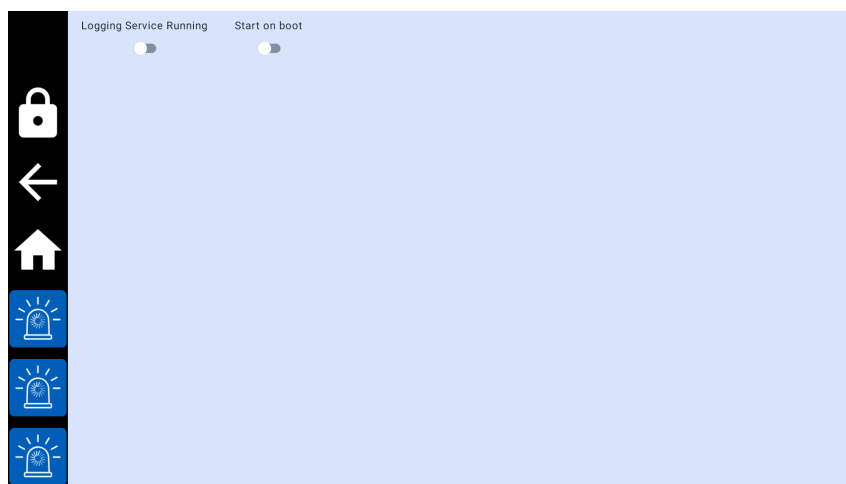

- 2) Select your preferred storage device:

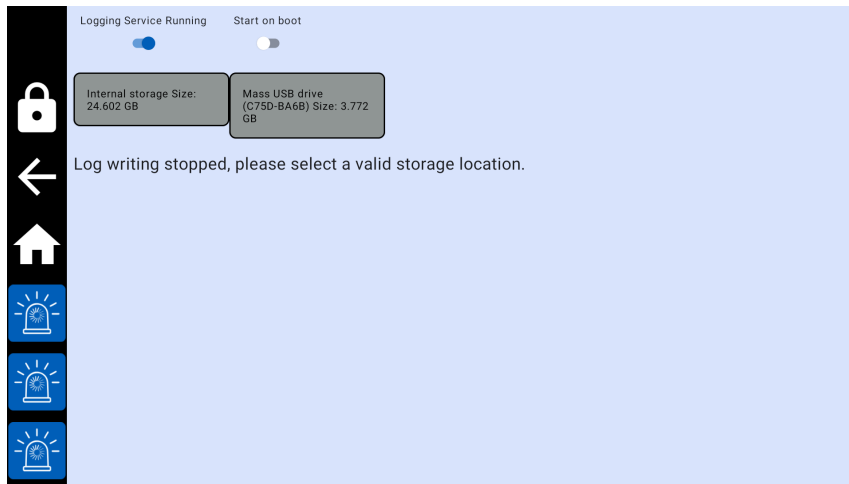

3) Adjust maximum size of total logs:

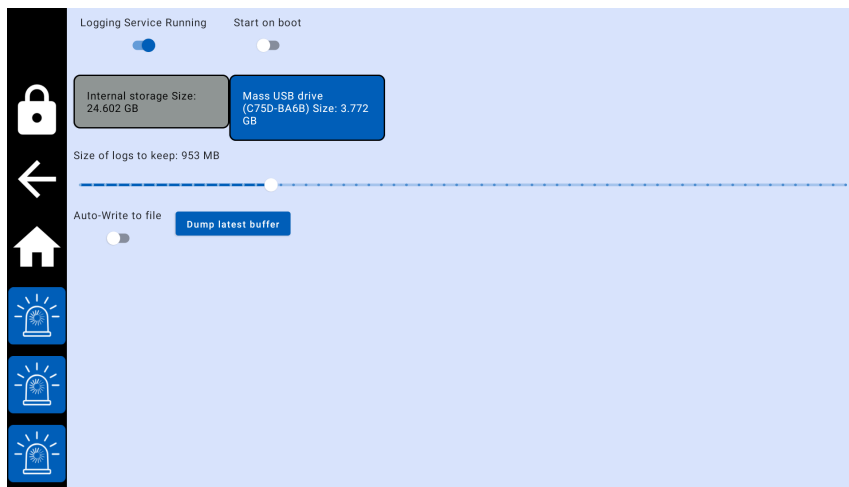

4) Enable auto-writing logs:

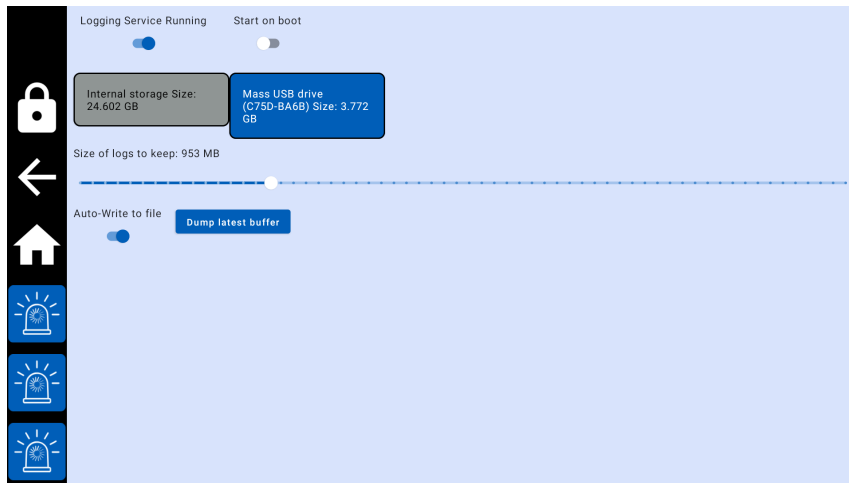

### 10.1.4 Enable user-facing log button

The Logging app can be added to the home screen or navigation bar (see section 4.6 for details). When the app is on either the home screen or navigation bar, it functions like the “Dump latest buffer” button. So any user can initiate the writing of log files by clicking the app icon. Logging must be enabled and set up for this to work.



### 10.1.5 Extracting log files from the Cobalt Cube

When you are ready to retrieve the log files from the Cobalt Cube, they will need to be moved to a computer, so they can be transferred to VNC Automotive. If they were saved directly to a USB device, then it can be removed and plugged into a computer for transfer. If the logs were saved to the internal storage device, the following steps can be used copy the logs to an attached USB.

1. Logs stored in the internal storage of the Cobalt Cube can be found at `/vnc/logging/`. This directory can be accessed by opening the files app and clicking “Show Internal Storage”:

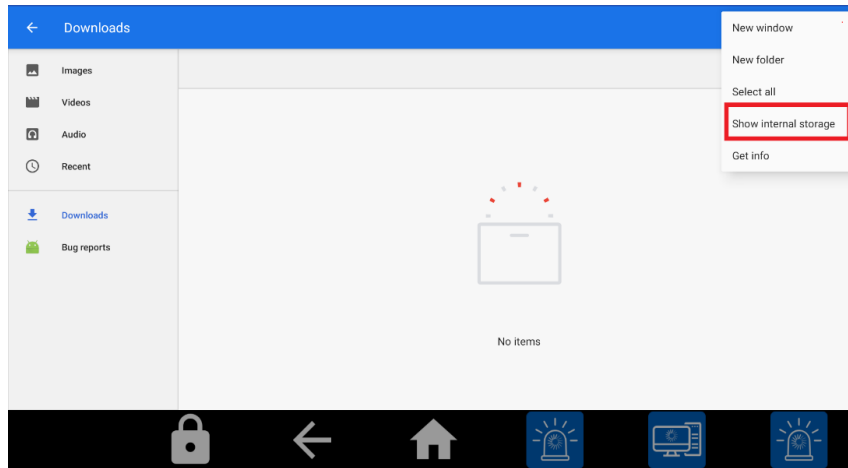

2. Select the Cobalt Cube storage device on the left-hand menu:

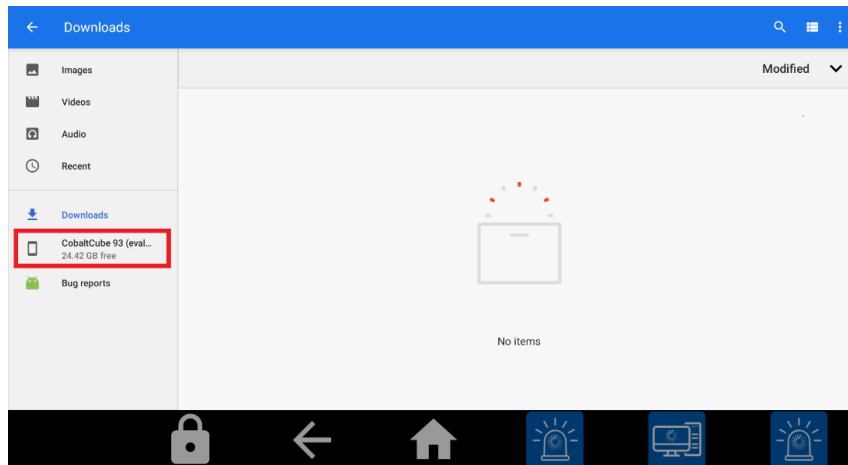

3. Navigate to `/vnc/logging/`:

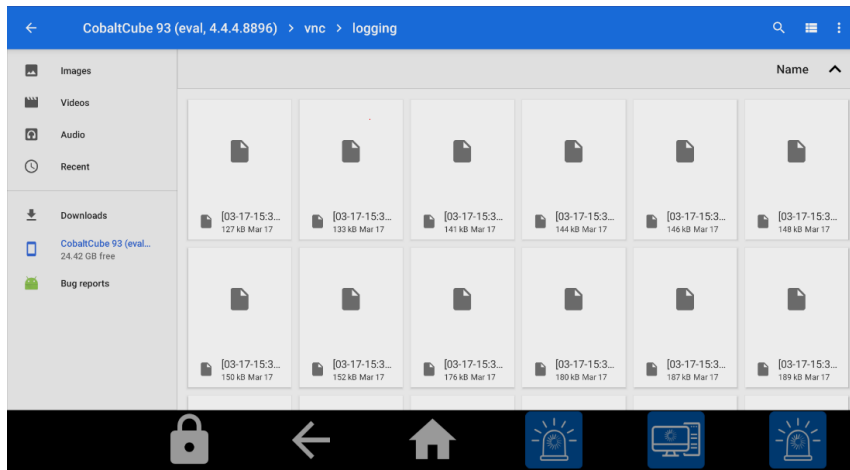

4. Long press to select the log(s) and select copy to in the menu at the top right:

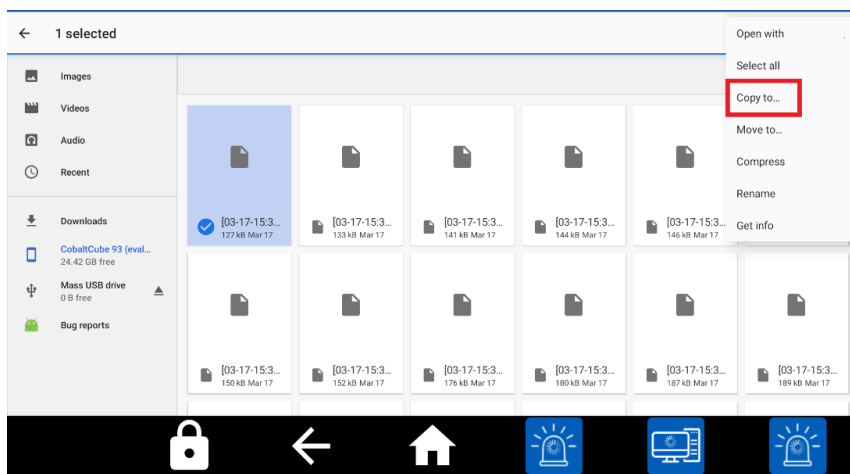

5. Navigate to the USB flash drive and click copy:

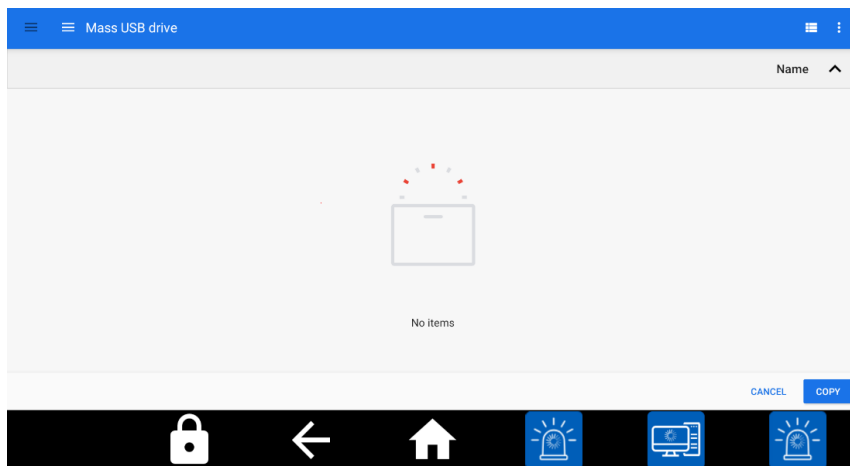

6. Once the files have been copied, they will show in the USB flash drive:

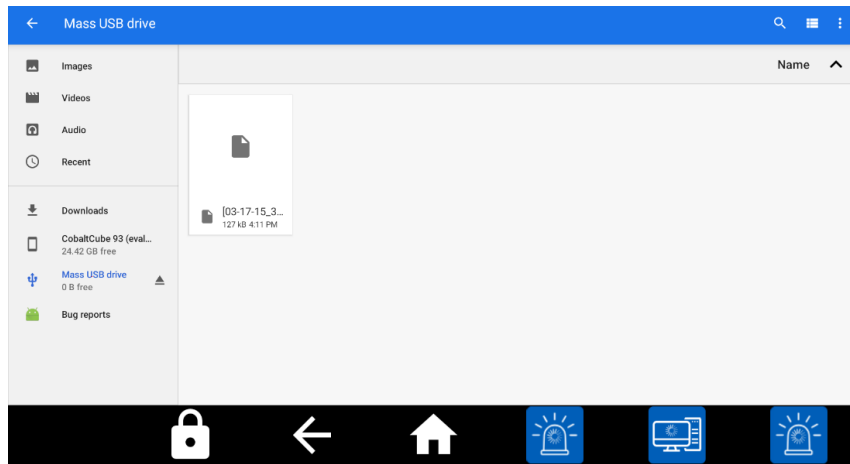

7. The USB flash drive can then be ejected, and the log files can be sent to VNC Automotive for examination.

## Let's discuss your project

As industry pioneers, we will help you cut through the complexity and deliver ingenious connectivity technology for the vehicles of tomorrow.

Get in contact via:

[www.vncautomotive.com](http://www.vncautomotive.com)

[technicalsupport@vncautomotive.com](mailto:technicalsupport@vncautomotive.com)

No part of this documentation may be reproduced in any form or by any means or be used to make any derivative work (including translation, transformation or adaptation) without explicit written consent of VNC Automotive.

All information contained in this document is provided in commercial confidence for the sole purpose of use by an authorized user in conjunction with VNC Automotive products. The pages of this document shall not be copied, published, or disclosed wholly or in part to any party without VNC Automotive prior permission in writing, and shall be held in safe custody. These obligations shall not apply to information which is published or becomes known legitimately from some source other than VNC Automotive.

